

MAGNAVOX

**VIDEO CASSETTE RECORDER
OWNER'S MANUAL**



MODEL VR9262

**Please See Inside
For 3 Important
Steps To Take
Before Operating
Your New VCR.**

Please Follow These Three
Important Steps To Get The
Most From Your Product

RETURN YOUR OWNER'S
REGISTRATION CARD WITHIN
10 DAYS.

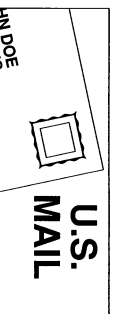

Registering your purchase is an essential step to guarantee you'll receive all of the benefits you're entitled to as a MAGNAVOX product owner. Complete and mail your Owner's Registration Card today to ensure your right to warranty verification, owner confirmation, model registration, plus a wide variety of special services and savings.

KNOW THESE SAFETY SYMBOLS.



▲ This "bolt of lightning" indicates uninsulated material within your unit may cause an electrical shock. For the safety of everyone in your household, please do not remove product covering.

▲ The "exclamation point" calls attention to a feature for which you should read the enclosed literature carefully to prevent operating and maintenance problems.

READ OPERATING
INSTRUCTIONS CAREFULLY.



The information in this manual can help you take full advantage of your product's many features, and ensure years of safe, reliable operation. So don't miss out. Read the enclosed instructions, safety tips and warranty information today.

MAGNAVOX

**Congratulations On Your New
Purchase ... And Welcome To The
MAGNAVOX Family!**

Dear MAGNAVOX Family Member:

Thank you for your confidence in MAGNAVOX. You've selected one of the best-built, best-backed products available today.

We appreciate your support, and we'll do everything we can to keep you happy with your purchase for many years to come. After all, you're the reason we're in business!

As a MAGNAVOX family member, you're entitled to a world of special privileges – and our uncompromising commitment to your total satisfaction. Your MAGNAVOX product is protected by one of the most comprehensive warranties and outstanding service networks in the industry.

What's more, your purchase qualifies you to receive advance information on exciting new products from MAGNAVOX, convenient access to our home shopping network for special products and accessories, plus factory-direct rebates and discounts on your future MAGNAVOX purchases.

All of this is our way of saying "thanks" for joining the MAGNAVOX family.

To start taking advantage of these great benefits, just remember to return your MAGNAVOX Owner's Registration Card.

Simply complete, detach and mail us your Owner's Registration Card today. And enjoy your new purchase with our best wishes!

Sincerely,

A handwritten signature in black ink, appearing to read 'Donald F. Johnstone'.

Donald F. Johnstone
President and Chief Executive Officer

For Customer Use:

Enter below the Serial No. which is located on the rear of the cabinet. Retain this information for future reference.

Model No. VR9262
Serial No. _____

Hello. We are pleased to introduce you to one of the most popular entertainment products available today.

Before you do anything else, record the Serial and Model Numbers in the spaces provided either on page two (just below the president's signature) or on the Warranty page at the back of this owner's manual. These numbers are located on the back of the VCR. Keep this manual and numbers near your VCR for quick reference or in case you should have to call for help.

Done? Good. You now have a legal description of your new VCR (Video Cassette Recorder).

This owner's manual is designed for you. To help you, keep certain things in mind. One, this book is divided into four sections. If you turn to page 4, you'll see that those sections are "Getting Started," "Describing Your Controls," "Doing More," and "Information You May Need."

To the right of each of these sections, you'll find a drawing of a dog. You'll also find these dogs in the upper corner of each page. The dog with a leash will be in the upper corner of the "Getting Started" section. The dog being described will always be in the upper corner of "Describing Your Controls" section. (You can even look at this section first, or any time you want.) The dog going for food will be in the upper corner of the "Doing More" section; and the dog reading will be found in the "Information You May Need" section. If you want, thumb through the book and check it out. Then come back. No hurry.

Taken a look? Good.

Two, at the very least, you should read all the numbered steps for those features you want to do. That way, you'll get the most out of it. And if you read and do all the features in the "Getting Started" section, you'll get the most out of your VCR.

There are a few more drawings you should know about. They mean different things. For example:

This drawing means "Read More."

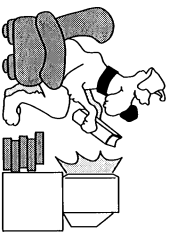

This drawing means "Ready? Go" on to the next feature.



Never be afraid to take the next step. You can't hurt your VCR. Certainly not by trying out any of the features. The features, like this manual, were made with you in mind.

This drawing means "Remember" something about a feature.



These drawings mean:

"Stop a Feature"



"Check or Clear a Feature"



"In case of power failure"



"Note about a Feature"



"Cancel a Feature"



These should all explain themselves as you read on. So...*Read On!*

Safety Precautions

WARNING: To prevent fire or shock hazard, do not expose this equipment to rain or moisture.

FCC WARNING: Any unauthorized changes or modifications to this equipment would void the user's authority to operate.

This video recorder, equipped with the HQ (High Quality) System, is compatible with existing VHS (Video Home System) equipment.

CAUTION:
TO PREVENT ELECTRIC SHOCK, MATCH WIDE
BLADE OF PLUG TO WIDE SLOT, FULLY INSERT.

Note to CATV System Installer:

This reminder is provided to call the CATV (Cable TV) System installer's attention to Article 820-40 of the NEC that provides guidelines for proper grounding and, in particular, specifies that the cable ground shall be connected to the grounding system of the building, as close to the point of cable entry as practical.

PHILIPS CONSUMER ELECTRONICS COMPANY recommends that you use only cassette tapes which have been tested and inspected for use in 2, 4, 6 and 8 hour video cassette recorders, and which are labeled with the **VHS**

mark. The use of tapes which have not been tested and inspected for 2, 4, 6 and 8 hour recorders may result in poor picture quality and excess deposits on the VIDEO head, which may not be covered by the warranty if damage occurs.

ATTENTION:
Pour éviter les chocs électriques, introduire la lame la plus large de la fiche dans la borne correspondante de la prise et pousser jusqu'au fond.



Getting Started

- Welcome 3
- Table of Contents 4
- Before Using Your VCR 5
- Hook Up Your VCR 6-7
- Turn On Your VCR 7
- Channel Memory Review 8
- Play a Tape 8
- Set the Clock 9
- Record on a Tape 10
- Record One Channel/See Another 11

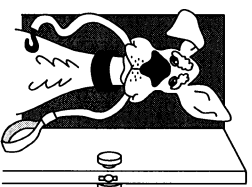

Describing Your Controls

- Describing Your Remote Control and VCR 12-17
- On Screen Displays 18

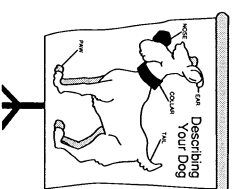

Doing More

- One Touch Recording (OTR) 19
- Timer Recording 20-21
- Re-Recording (Tape Duplication) 22
- Special VCR Features 23
- Special Playback Features 24-25
- MTS (Multi-Channel Television Sound) Broadcast Stereo System 26
- VHS Hi-Fi Stereo Sound System 27
- Tape Operation 28
- TV Code Setting 29

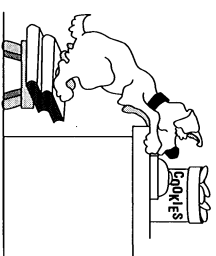

Information You May Need

- Notes on Operations 30-31
- Specifications 31
- Other Hook-Ups You Can Try 32-35
- Before Requesting Service 36-37
- Warranty 37
- Glossary 38
- Index 39
- Accessories 40



Features

- HQ (High Quality) System
- Frequency Synthesizer Tuning with Auto Set Feature
- On Screen Display (OSD) with English/Spanish Selectable Screens
- Indicator Panel
- MTS (Multi-Channel Television Sound) System
- Hi-Fi Stereo Sound System
- Auto Tracking
- One Touch Recording (OTR)
- Unattended (Timer) Recording
- Special Effects Playback
 - Fast Search
 - Still
 - Variable Slow
 - Frame Advance
- Wireless Remote Control with Jog/Shuttle Control and Multi-Band TV Control Capability
- Auto Operation Functions
- Real Time Counter

Before Using Your VCR

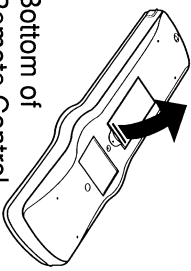
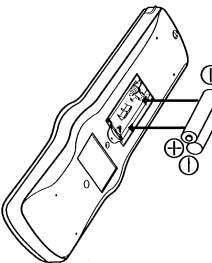
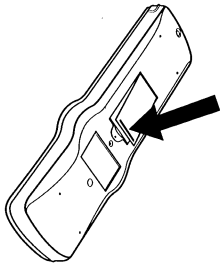

1 Load the batteries as follows:

<p>1 Remove the Battery Compartment lid from the bottom of the remote control.</p>  <p>Bottom of Remote Control</p>	<p>2 Install two batteries as indicated inside the Battery Compartment.</p> 	<p>3 Replace the lid.</p> 
---	--	--

Battery Replacement Caution

- Do not mix old and new batteries. (Also never mix alkaline batteries with manganese batteries.)



This remote control and batteries are supplied accessories. Please check to make sure they are included. Also, check the Accessories page on the back of this book to see what other accessories are included.

2 Types of Video Cassette and Tape Speeds

You can change the recording speed for a tape using the **Tape SPEED** button on the remote control (see page 13).

- 2 Recording speeds: SP, SLP
- 3 Playback speeds: SP, LP, SLP

In this VCR, use only tapes with the **VHS** mark. The chart below shows the recording/playback time for 3 types of tapes (T160, T120, T60).

Tape Speed Selector Position	Type of Tapes	T160	T120	T60
		Maximum Record/Playback Time		
SP (Standard Play)		2 Hours 40 Minutes	2 Hours	1 Hour
LP (Long Play)(Playback only)		5 Hours 20 Minutes	4 Hours	2 Hours
SLP (Super Long Play)		8 Hours	6 Hours	3 Hours

* During Playback, the VCR selects the tape speed, SP, LP, or SLP, automatically.

3 Erase Protection

Cassettes have a Record Tab to ensure that recordings are not accidentally erased.

- To prevent accidental erasure:

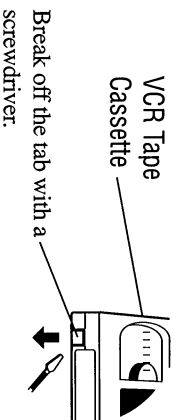

- To record again:

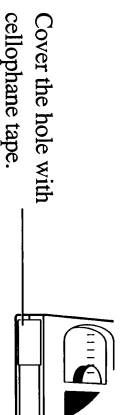

4 Please Read and Relax

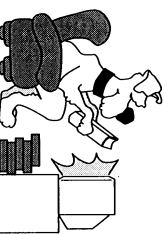

Please read all the instructions for each feature before attempting that feature. For example, read all the steps for Timer Recording (pages 20-21) before doing a Timer Recording.



...to the next page to begin hooking up your VCR.



6

Hook Up Your VCR

Antenna or Cable to VCR to TV Hook Up

(For other possible hook ups, please see pages 32-35.)

Step 1: Disconnect the Antenna or Cable from Your TV.

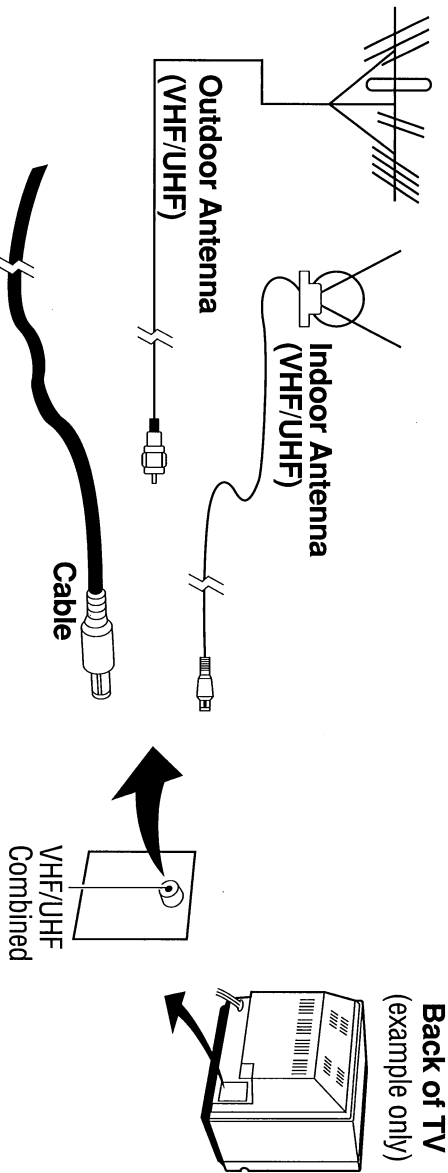

Step 2: Connect Your Antenna or Cable to Your VCR.

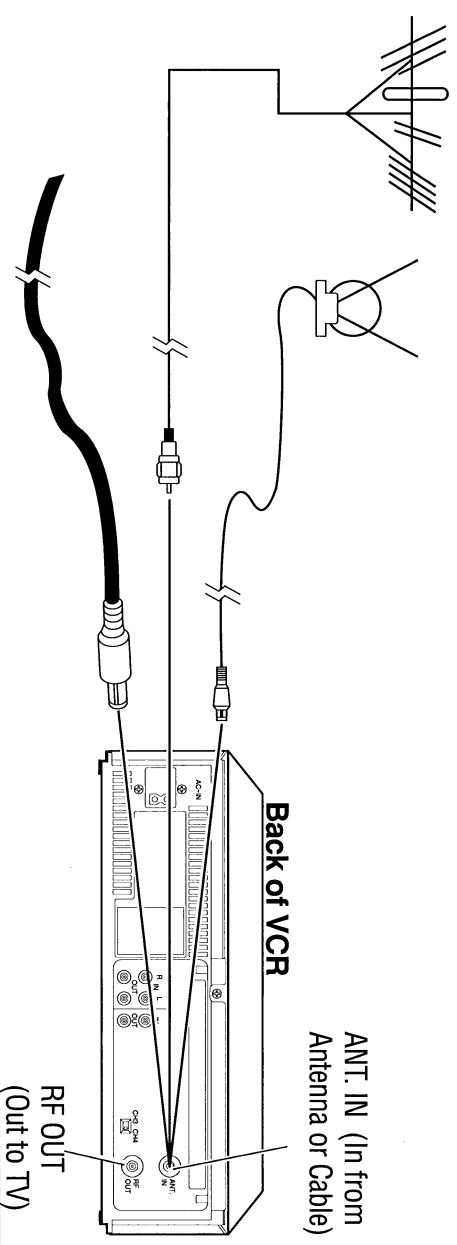

Step 3: Connect Your VCR to Your TV.

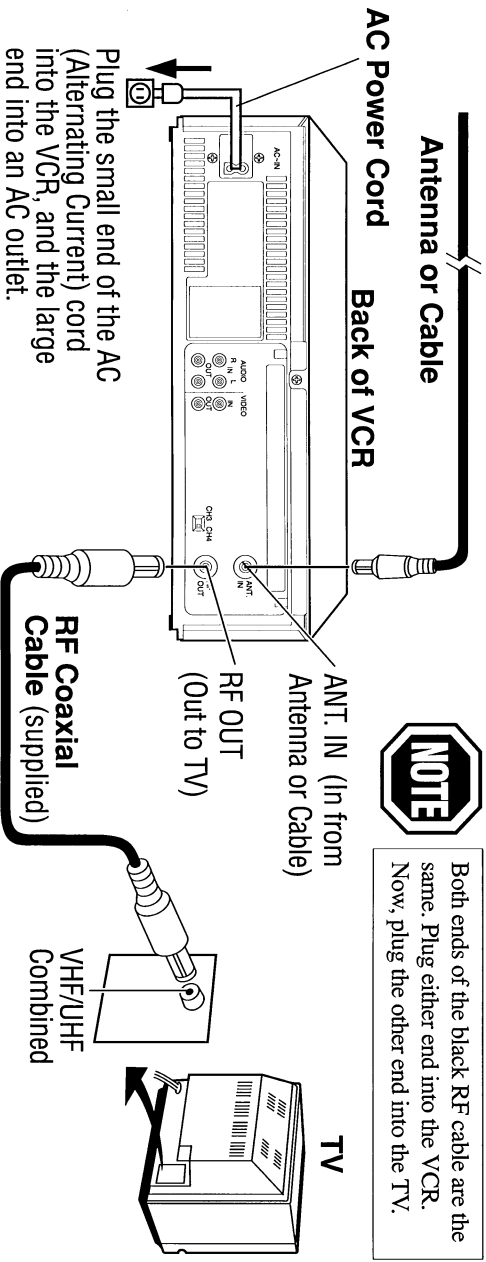

(Continued on next page.)

Hook Up Your VCR (continued)

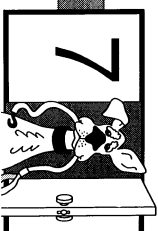

Step 4: Select Channel 3 or 4.

Set the CH3/CH4 switch on the back of the VCR to channel 3 or 4. To operate the VCR with your TV, set your TV to the same channel. For example, if your switch is set to channel 3 (CH3), turn your TV to channel 3.

To avoid local interference, the CH3/CH4 switch position you choose should correspond to the local TV channel that is not used or least used.

If both are used, select the channel that gives you the best picture when playing a tape.

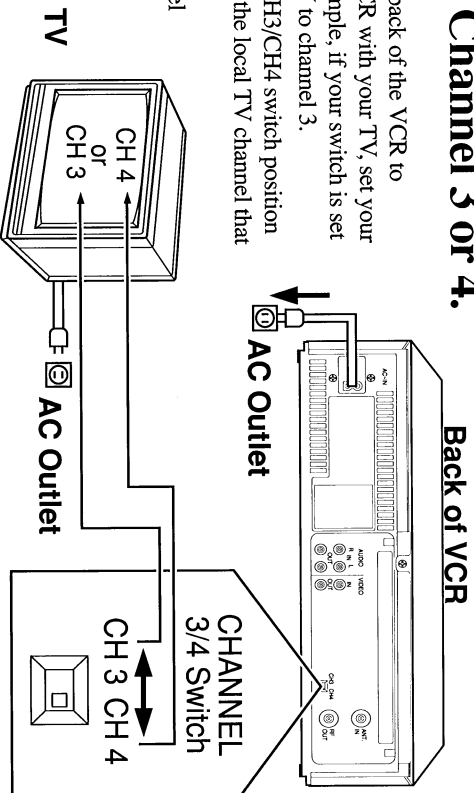

...turn on the VCR to see if you have made the right connections.



Turn On Your VCR

Make sure ...

the batteries are loaded in the remote control and the hook ups on pages 6 and 7 have been completed before continuing to the steps below.

At the TV

- 1 Turn the TV on. Set the TV to the same channel as the CH3/CH4 Switch on the back of the VCR. (See "Step 4" at top of this page.)

Choose Your Language

First, press the VCR POWER button.

The VCR comes on and the Language Select menu appears. This menu asks you to select a language from your On Screen Display.

- 2 Next, press the NUMBER 1 button if you want English. Or, press the NUMBER 2 button if you want Spanish. Now, press the MENU button.

TV
Screen

TO SELECT PUSH NO. SHOWN
1 ENGLISH (ON)
2 ESPANOL.
MAKE SELECTION OR
PUSH MENU TO CONTINUE

Place Channels in VCR's Memory

After selecting language, the Channel Select menu at the upper right appears.

- 3 First, press the VCR CH(annel) UP button to begin automatic channel programming. The VCR detects if you have Antenna or Cable hooked to you VCR and places the channels it receives into the VCR's memory.

Now, wait while the VCR places channels in its memory. It only takes a minute or two.

After all channels have been programmed, "AUTO SET COMPLETED" is displayed, then the VCR displays the lowest channel number programmed.

AUTO SET PROCEEDING
PLEASE WAIT

CONNECT ANTENNA OR CABLE
TO VCR
THEN...
PUSH CH UP KEY
OR...
FOR PLAY ONLY, PUSH STOP

Back of VCR

AC Outlet

CHANNEL
3/4 Switch

CH 3 CH 4

AC Outlet

TV

VCR POWER
Button

VCR CH(annel)
UP Buttons

NUMBER
Buttons

MENU Button

Remote Control

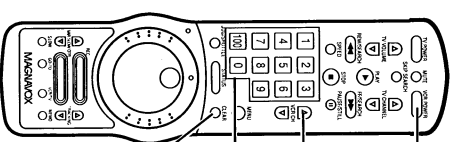

Fast Track Through This Feature

1. If the record tab on a cassette (page 5) is removed, playback starts automatically.

Or

2. First, to skip Step 2, press the MENU button. All on screen displays will be in English. Now, to skip Step 3, press the STOP button. You can now play a pre-recorded tape.

Notes:

If channel programming is done without an Antenna or Cable hook up, the on screen display will say "NO TV SIGNALS," then ask you to check connections and try again.

You can place channels into memory manually at a later time. For details, see page 23.

You can select the language manually at a later time. For details, see page 18.



You do this feature one time. You only repeat it if there is a power failure, or if you move your VCR. In these cases, the VCR will prompt you when you turn it on.

If you do not see any on-screen displays, please repeat the four steps under "Hook Up Your VCR," pages 6 and 7.



...to the next page to find out what channels are in the VCR's memory.



8

Channel Memory Review

- TO SELECT PUSH NO. SHOWN
- 1 PROGRAM
 - 2 VCR SET UP
 - 3 TUNER SET UP
 - 4 MENU SELECT
 - 5 CLOCK SET

TO END PUSH MENU

Main Menu

NUMBER Buttons

MENU Button

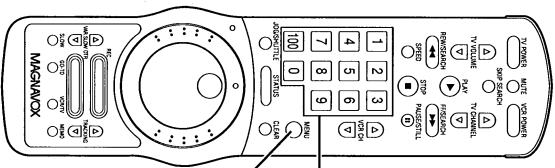

Remote Control

Make sure ...
batteries are in the remote control (page 5), all the steps on pages 6 and 7 have been completed, and the TV and VCR are on.

At the Remote Control

First, press the MENU button. The main menu appears.

- 1 Next, press the NUMBER 3 button to select "TUNER SET UP."

Now, press the 5 button to select "CH MEMORY REVIEW". The memorized channel list appears on the TV screen.

MEMORIZED CHANNEL: CABLE TV Screen	
15	17
20	21
27	31
32	36
42	43
45	47
50	51
52	66
64	67
68	70
73	75
78	80
81	83
84	86
88	89
90	92
95	104
107	112

NEXT = 1 PREVIOUS = 2
TO END PUSH MENU

To View all Memorized Channels

- 2 To see the next channel list, press the NUMBER 1 button. To see the previous list, press the NUMBER 2 button. If the screen does not change, there are no other memorized channels.

To exit, press the MENU button.



...below and "Play a Tape." This is another way to make sure you have made the right hook ups.

Play a Tape

Make sure ...
the batteries are loaded in the remote control and the hook ups on pages 6 and 7 have been completed before continuing to the steps below.

At the TV

- 1 Turn the TV on. Set the TV to the same channel as the switch on the back of the VCR (CH3/CH4).

At the VCR

- 2 Insert a cassette.*
• The VCR Power will come on.

Start Playback

Press the PLAY button.

- 3 The VCR mode is automatically set and the VCR light will come on.

Stop Playback

Press the STOP/EJECT button to stop playback.

- 4 Press the REWIND button to fully rewind the tape.
• Press the STOP/EJECT button again to remove the tape.

* If a cassette's record tab (page 5) is removed, playback starts automatically.

• If a cassette is already in the VCR, just press the POWER button.

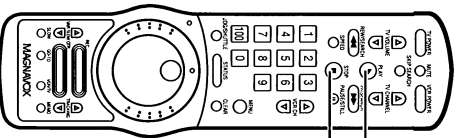
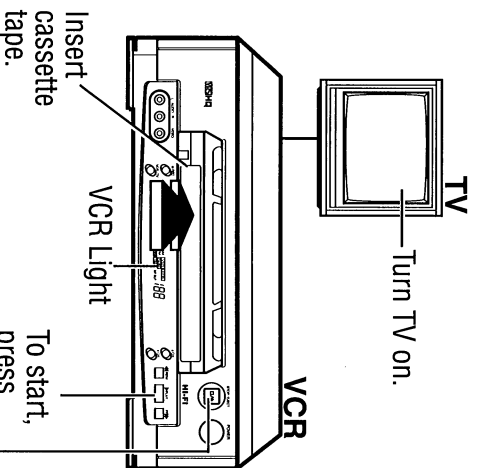

Remote Control



...to the next page and learn more about the NUMBER buttons. Set the clock!

Set the Clock



To set your VCR to the present day and time, follow steps 1-4 below. Once set, your VCR (Video Cassette Recorder) will maintain the time in its internal clock, and will make timer recording possible.

Make sure ...

- your VCR and TV are connected and turned on (see pages 6-7).
- the VCR light says "VCR" (see page 14).
- to make each entry within 10 seconds; otherwise the VCR will exit the Clock Set mode and you will have to start over.

Select the Clock Set Mode

- 1 First, press the MENU button. Next, press the NUMBER 5 button to select "CLOCK SET" from the main menu screen.

TV Screen

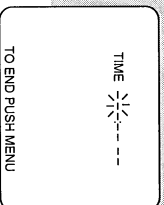

Set the Time & AM or PM

- 2 First, press two NUMBER buttons for the hour, then two NUMBER buttons for the minutes, and finally press "1" for AM or "?" for PM. For example, for 10:30 PM, press the NUMBER buttons 1-0, 3-0, 2.
 - When setting the clock for the first time, entries that do not match the VCR's internal calendar will cause a "?" to appear.
 - Always enter "0" before any single-number entries.
 - To make corrections, press the CLEAR button repeatedly to move back to an item then enter the correct number.

Set the Month, Day & Year

- 3 Press two NUMBER buttons for the month, two NUMBER buttons for the day, and two NUMBER buttons for the year. For example, for July 1, 1993, press the NUMBER buttons 0-7, 0-1, 9-3. The day appears automatically.

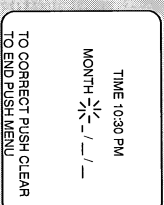

Start the Clock

- 4 Press the MENU button. Clock starts and the screen returns to the program you were on.

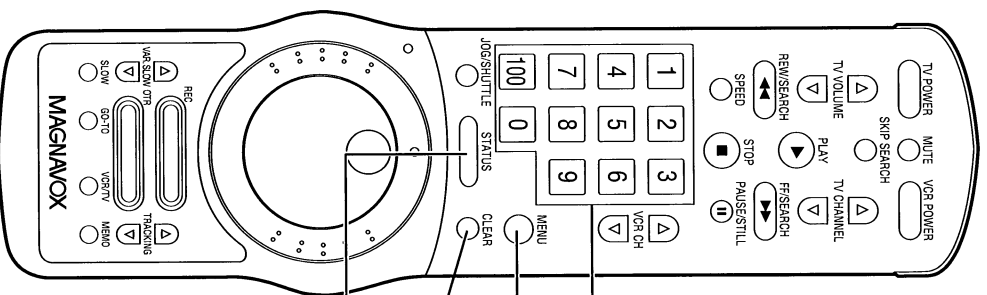
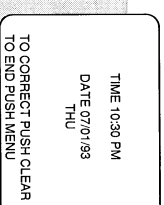

Remote Control

To Display the Time

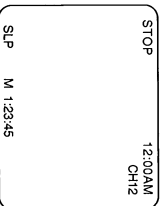

Press the STATUS button. A status display, including the time, will appear on the TV screen. For details, see page 18, "VCR Status Display."

To Reset the Clock

Press the MENU button. The TV and VCR must be on and the VCR in the "VCR" mode. The main menu screen will appear. Press the NUMBER 5 button and follow the clock set guide to re-enter the new date and time.

- TO SELECT PUSH AND SHOW
- 1 PROGRAM
 - 2 VCR SET UP
 - 3 TUNER SET UP
 - 4 INPUT SELECT
 - 5 CLOCK SET
- TO END PUSH MENU



Power failures can cause you to lose both your clock setting and local channels placed in the VCR's memory. Should this happen, repeat steps on pages 7 and 9 before doing anything else.



...to the next page and do a recording!



10

Record on a Tape

To record on a cassette tape, follow steps 1 – 7 below. Read all the instructions before starting. You must use your remote control.

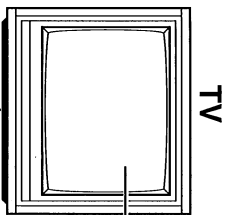

Power ON:
Select channel
3 or 4.

VCR Light

VCR

STOP Button

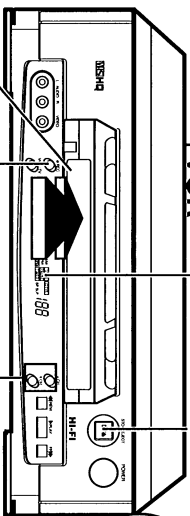

Cassette RECORD
Tape Button

CHANNEL
UP/DOWN
Buttons

Make sure ...
the steps in "Hook Up Your VCR" on pages 6 – 7 have been completed.

At the TV

- 1 Turn the TV on. Turn to channel 3 if the VCR CH3/CH4 switch is set to "CH3." Turn to channel 4 if the VCR is set to "CH 4."

At the VCR

- 2 Insert a cassette with the record tab in place. The power will come on. If the cassette is already in the VCR, press the POWER button. If the VCR light comes on, do nothing. If it doesn't, press the VCR/TV button.

Choose the Tape Speed

- 3 (You may skip this step if the desired tape speed is already selected.) Press the TAPE SPEED button on the remote control until the desired tape speed (SP, SLP) appears on the TV screen.

Choose the Channel

- 4 Press the VCR CH(annel) UP/DOWN or NUMBER buttons to select the channel to be recorded.

Start Recording

- 5 Press the REC(ord) button.

Pause Recording

- 6 To pause, press the PAUSE/STILL button. To continue recording, press this button again.

Stop Recording

- 7 To stop, press the STOP button.

Using the 100 Button

To record or watch channels 100 to 125 with the NUMBER buttons, first press the NUMBER 100 button, then enter the remaining two numbers. For example, for channel 105, press NUMBER buttons 100, 0, 5. For channel 100, press NUMBER buttons 100, 0, 0.

Remote Control

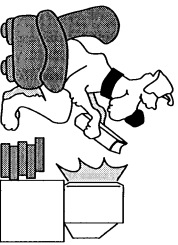
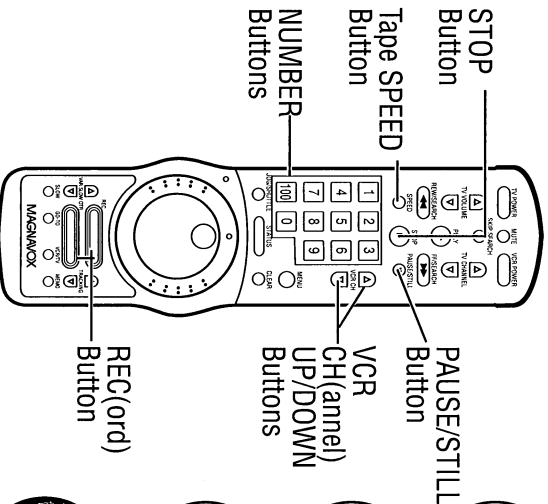

Other recording options are available on pages 19–22.



...to the next page and learn how to record one channel while watching another.



To record one channel while viewing another, follow steps 1–4 below. Please read all the instructions. You must use your remote control.

Start a Recording

1 Start a recording as described on page 10.

Set the VCR/TV Button

2 Press the VCR/TV button to select the TV mode. The VCR light and channel being recorded disappears.

Select the Channel at the TV for Viewing

3 Select the channel to be viewed at the TV, using the channel controls on the TV or TV remote control.

The channel selected with the TV channel controls appears on the TV screen. The channel selected with the VCR channel control is recorded on the tape.

To Return to the Channel Being Recorded

4 First, using the channel controls on the TV or TV remote control, return the TV to either channel 3 or 4 (Please see page 7, “Hook Up Your VCR.”)

Now, press the VCR/TV button to view again the channel being recorded.

Choose Input Source

First, press the MENU button. Next, press the NUMBER 4 button to select “INPUT SELECT.” Now, press the NUMBER 1 button to select “TUNER.” “(ON)” appears beside “TUNER.” To exit, press the MENU button once.*

TO SELECT PUSH NO. SHOWN (ON)
1 TUNER
2 AV IN REAR
3 AV IN FRONT
TO END PUSH MENU

TV Screen

* If you are not receiving channels, please repeat the steps on page 6 – 7 of this book. Also, follow carefully the instructions listed above.

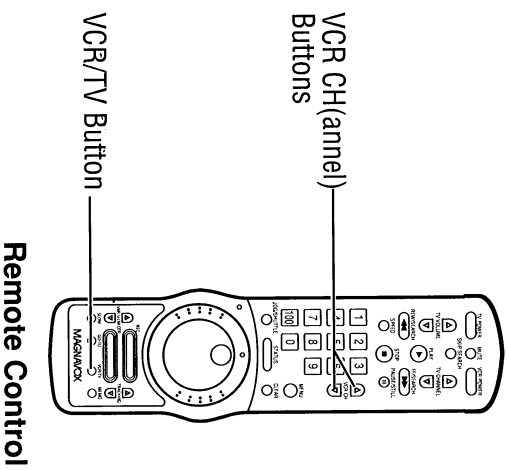
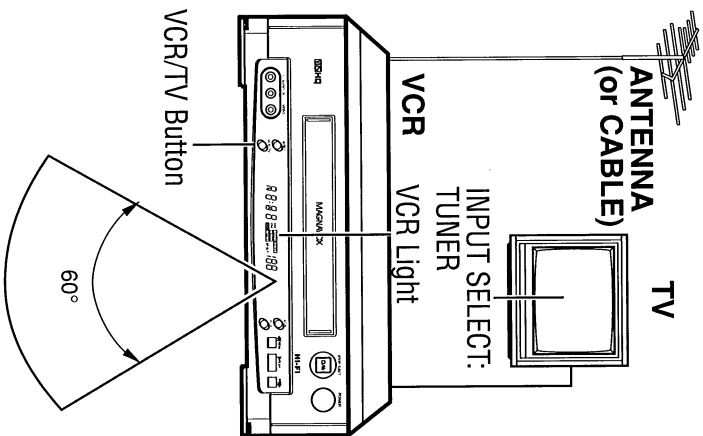

Point the transmitter toward the VCR's remote sensor, within the angle shown in the illustration above.



If you use a converter box or satellite system hook-up, you may not be able to do this feature.



Congratulations! You've taken many steps. Now, turn to the next page and find out a little more about your VCR and remote control.

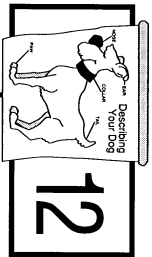

Describing Your Controls

Remote Control Transmitter

SKIP SEARCH Button

Press during playback mode to skip forward 30 seconds on tape counter. Press up to 4 times consecutively to skip up to 2 minutes on the tape counter. VCR will automatically return to Playback mode.

STOP Button

Press to stop the tape.

VCR POWER Button

Press to turn VCR power ON or OFF. Also, to set the VCR for unattended timer recording.

FF (Fast Forward)/SEARCH Button

To move the tape forward at high speed. Also, during playback, press this button for rapid forward visual search. For details, see page 24.

PAUSE/STILL Button

- Press once to temporarily stop the tape during recording (Pause).
- Press once to freeze the tape picture during playback (Still). Press again when you want to resume normal playback or recording. For details, see page 24.

VCR CH(annel) UP/DOWN Buttons

Press “ Δ ” or “ ∇ ” to scan up or down through the VCR’s channels. Release at desired channel.

MENU Button

Press to call up the on-screen menu display. For details, see page 18.

STATUS Button

Press this button to display the time counter, time, function, and channel number. For details, see pages 9 and 18.

CLEAR Button

- To erase incorrect or unwanted data in on-screen menu operation.
- To reset the tape counter. “0:00:00” will appear on the TV screen.

REC(ord) Button

Press to start recording. For details, see page 10.

ONE TOUCH RECORDING (OTR) Button

Select the channel and press this button to start an immediate recording 30 minutes to 9 hours long. Each press delays the shut-off time by 30 minutes. Power shut off is automatic. For details, see page 19.

TRACKING Buttons

In the Play and Slow modes, when playing a tape, press TRACKING “ Δ ” or “ ∇ ” button to adjust the tracking. For details, see page 25.

MEMO(r)y Button

Press to memorize the tape position at which the counter was reset to “0:00:00.” For details, see page 28.

VCR/TV Button

Press to select the signal source that your TV receives.

VCR position (VCR light on the display panel: ON)

To watch a tape, monitor a recording, or watch a TV broadcast selected with the VCR’s CH(annel) UP/DOWN or NUMBER buttons.

TV position (VCR light on the display panel: OFF)

To watch TV or to watch one program while recording another. For details, see page 11.

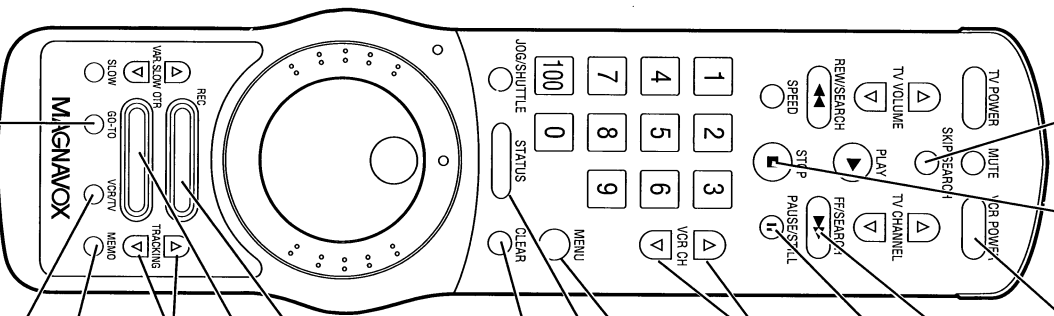

GO-TO Button

This button can make search easier by allowing you to skip back or ahead on a tape. Press this button and select desired counter number with NUMBER buttons. For details, see page 28.

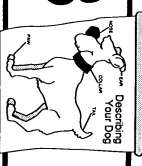

Remote Control Transmitter

This remote control may operate your TV. First, point the remote control at the TV and press the remote's TV POWER button. If the TV turns on, try the other TV Control buttons listed below. If your TV does not turn on, please see page 29, "TV Code Setting."

TV Controls

MUTE Button

Press to instantly reduce the TV's sound level. Press again to return to previous setting.

TV POWER Button

Press to turn TV power ON or OFF.

VOLUME UP/DOWN Buttons

Press "▲" or "▼" to increase or decrease the TV's sound volume.

TV CHANNEL UP/DOWN Buttons

Press "▲" or "▼" to scan up or down through the TV channels. Release at desired channel.

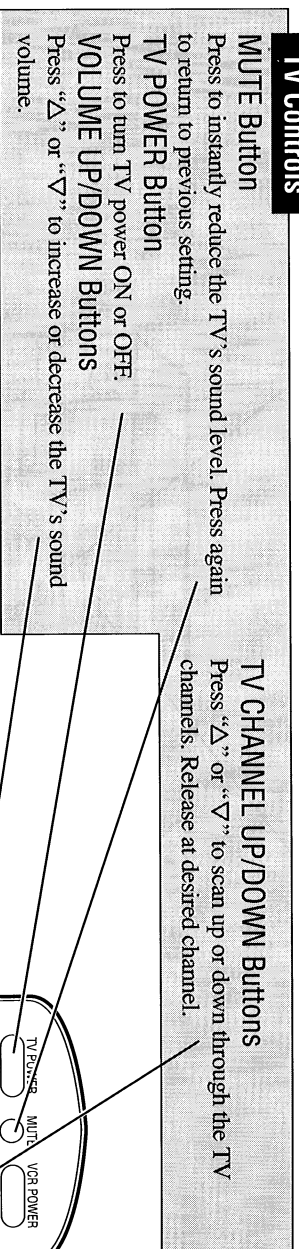

PLAY Button

- Press to play back a tape. For details, see page 8.
- Press to release the Slow or Search mode and return to playback. For details, see page 24.

REW/(ind)/SEARCH Button

Press to rewind the tape at high speed. Also, during playback, press this button to view the picture in rapid reverse visual search. For details, see page 24.

Tape SPEED Button

Press to select recording speed (SP, SLP). In playback, the tape speed is automatically selected (SP, LP, SLP). For details, see pages 5 and 15.

NUMBER Buttons

(0, 1, 2, 3, 4, 5, 6, 7, 8 and 9)

Use for channel selection, on-screen menu selection, clock setting, program setting, etc. For selecting channels 1 to 9, first press "0" button and then press "1" to "9."

(100)

Press this button first when selecting channels 100 and higher. For details, please see page 10.

JOG/SHUTTLE Button

Press to use the Jog Dial or the Shuttle Ring.

Jog/Shuttle Light

Lights up when the JOG/SHUTTLE button is pressed.

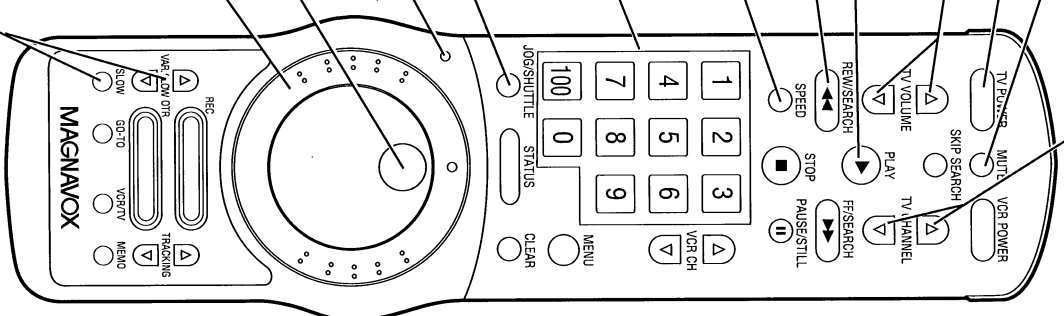

Jog Dial

Turn this dial while in the Still mode in either direction for jog control. The tape moves forward or backward frame-by-frame at the speed with which the dial is turned. For details, see page 24.

Shuttle Ring

Turn this ring while in the Play or Still mode in either direction.

The farther the ring is rotated, the faster the search speed. Releasing the ring stops the picture in the Still mode. For details, see page 24.

SLOW/VAR(iable) SLOW Buttons

First press the SLOW button during SP or SLP playback to view a slow-motion picture. The speed can be varied from about 1/6 to about 1/30 of normal speed with the VAR(iable) SLOW button. For details, see page 24.

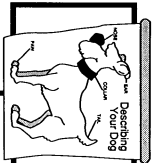

VCR Display Panel

Cassette Compartment
Where the video cassette is inserted.

VCR Display Panel
Where information on various VCR operations is displayed.

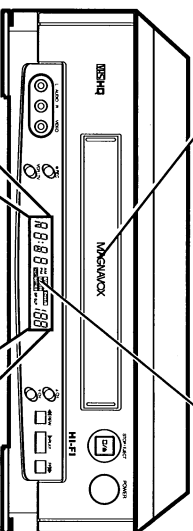

VCR Light: "VCR"

Lights up when the VCR mode is selected.
For an example, see page 10.

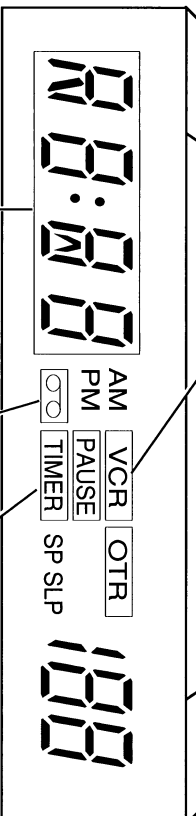

Digital Clock _____
After setting the clock, the present time is displayed here.

Feature Display _____
Displays which feature the VCR is currently performing.

PLAY	: Playback
REC	: Recording
FF	: Fast forward
REW	: Rewind

Timer Light: "TIMER"
Lights up when the VCR is set for (unattended) Timer Recording.
For details, see pages 20-21.

Cassette-Inside Light
Lights up when there is a cassette in the unit.

VCR Display Panel

Wireless Remote Sensor

Receives the signal from the (wireless) remote control. For details, see page 11.

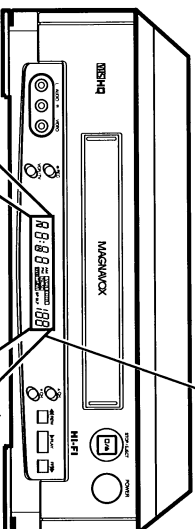

OTR Light: "OTR"

Lights up when the One Touch Recording (OTR) feature is in use. For details, see page 19.

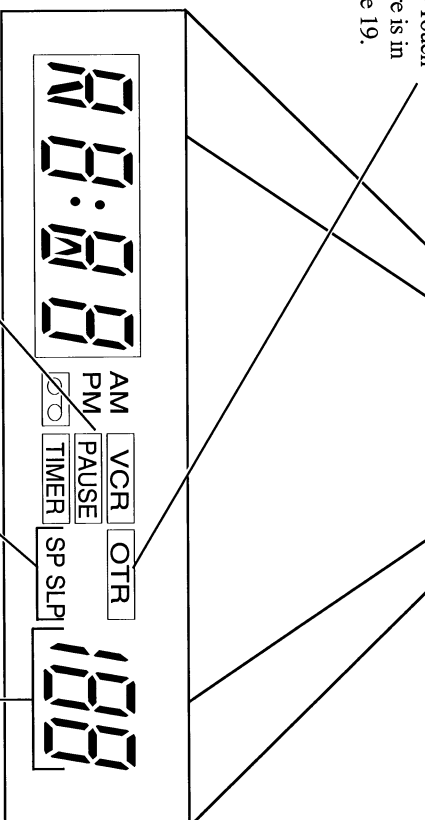

Pause Mode Light: "PAUSE"

Lights up when the VCR is in the Still, Slow, or Record-Pause mode.

Speed Light: "SP" or "SLP"

Shows the tape speed during recording (SP or SLP) and playback (SP or SLP).

SP – Standard Play

SLP – Super Long Play

For details, see page 5.

Note:

Tapes recorded in LP (Long Play) can be played back on this VCR. "LP," however, will not appear on the display panel.

Channel/Input Signal Light

Shows the channel number. For example, 2 means channel 2

"L" means External Line Input Signal is selected.

Select Line mode by pressing NUMBER buttons 0-0.

To exit Line mode, press any other number, for example, 0-2. "2" appears on the VCR Display Panel.

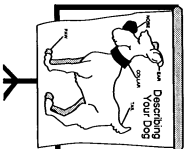

Front Panel

STOP/EJECT Button

Press to stop the tape. Press again after the tape has stopped to eject the cassette.

PLAY Button

- Press to play back a tape.
- Press to release the Slow or Search mode and return to playback.

RECORD Button

Press to start recording.
For details, see page 10.

POWER Button

Press to turn the VCR (Video Cassette Recorder) on and off. To set the VCR for unattended recordings after timer settings have been completed.

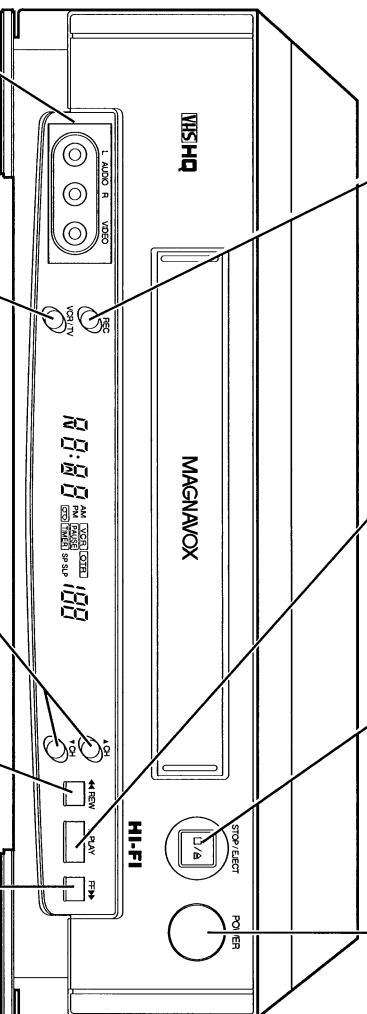

Front AUDIO/VIDEO IN(put) jack

For hook up from the audio and video out(put) jacks from another VCR or a portable video camera (camcorder).
For details, see page 22.

CHANNEL UP/DOWN Buttons

Press to scan up or down through the VCR's channels. Release at desired channel.

FF (Fast Forward) Button

Press to move the tape forward rapidly. Also, during playback, press this button for rapid forward visual search.
For details, see page 24.

VCR/TV Button

Press to select the signal source that your TV receives.

VCR position (VCR light on the display panel: ON)

To watch a tape, monitor a recording, or watch a TV broadcast selected with the VCR's channel selector.

TV position (VCR light on the display panel: OFF)

To watch TV or to watch one program while recording another.

REW(ind) Button

Press to rewind tapes. Also, during playback, press this button for reverse visual search.
For details, see page 24.

Rear Panel

AUDIO IN(put) Jacks

For audio input hook up from the output jacks of a portable video camera, another VCR, or another audio source. For details, see page 22.

ANT(enna) IN(put) Jack (in from Antenna)

Hook up your antenna or cable to this jack. For details, see pages 6-7.

VIDEO IN(put) Jack

For video input hook up from another VCR or a portable video camera.

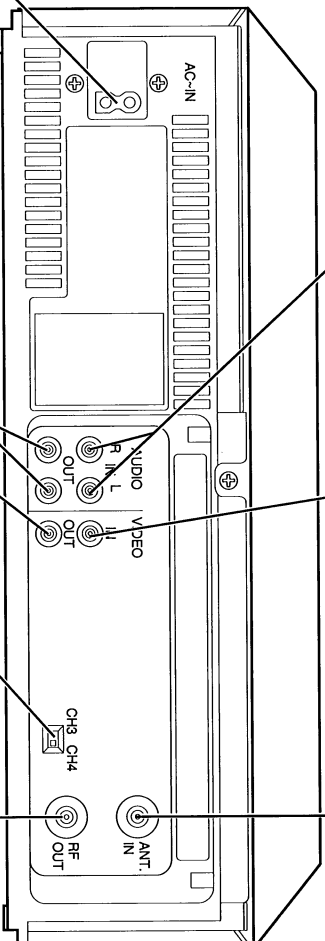

AC (Alternating Current) Power Connector

Connect the small end of the supplied AC Power Cord to this terminal, and then connect the large end of the AC Power Cord to a 120 V/60Hz household outlet.

CH3/CH4 Switch

Set to channel 3 or 4 (whichever is not used for regular TV broadcasting in your area) to use your TV as a screen for your VCR. See "Hook Up Your VCR" on pages 6 & 7.

VIDEO OUT(put) Jack

For hook up to the video input jack on a TV or another VCR. For details, see page 22.

AUDIO OUT(put) Jacks

For hook up to the audio input jack on a TV, another VCR, or an audio tape recorder. For details, see page 22.

RF OUT(put) Jack (out to TV set)

Use the supplied cable to hook up this terminal to the VHF/UHF input jack on your TV set. For details, see pages 6-7.

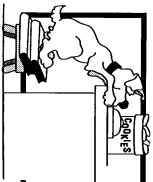

18

On-Screen Displays (OSD)

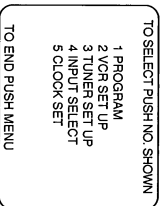

Main Menu

Press the **MENU** button on the remote to display the main menu screen. Then press the **NUMBER** button on the remote control for the desired feature displayed on the menu. When you select a feature, turn to the section in this manual and read the accompanying instructions.

OSD Main Menu Screen

VCR Status Display

1. Press the **MENU** button.
2. Next, press the 2 button to select "VCR SET UP."
3. Then, press the 1 button to select "ON SCREEN MODE."
4. Now, press the 1, 2, or 3 button to select "ON SCREEN ON," "COUNTER ONLY" or "ON SCREEN OFF."
" [ON]" appears beside the selection mode.

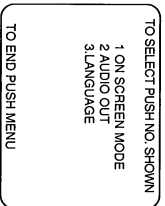

VCR Set Up

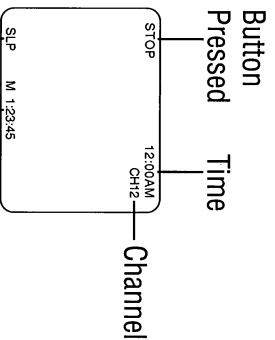

VCR Status Display

- POSITION**
- **ON SCREEN ON:** Whenever a function button (Stop, FF, etc.) is pressed, a 5 second VCR Status Display appears.
 - **COUNTER ONLY:** Whenever a function button (Stop, FF, etc.) is pressed, a 5 second VCR Status Display appears.
 - After 5 seconds, the counter information will remain on the screen.
 - **ON SCREEN OFF:** In this position, there will be no indication when normal functions are pressed.
 - Except in the **ON SCREEN OFF** mode:
 - You may display the VCR Status any time by pressing the **STATUS** button. Status display remains on for 5 seconds.
 - Channels (when tuned) are displayed as an overlay for a few seconds.

OSD Language Select

1. Press the **MENU** button.
 2. Next, press the 2 button to select "VCR SET UP."
 3. Then, press the 3 button to select "LANGUAGE."
 4. Now, press the 1 or 2 button to select "ENGLISH" or "SPANISH."
- All OSD (On-Screen Displays) will appear in the language you select. " [ON]" will appear beside the selection if you choose English and " [SI]" will appear if you choose Spanish.

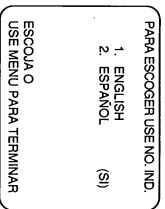
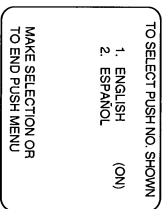

Blank Channel Indication

If the channel you select has no broadcast, the screen will change to a solid blue field. The screen will remain blue until an active channel is selected.

Language Selection Menu

One Touch Recording (OTR)

19

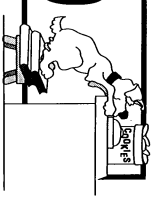

To set the VCR (Video Cassette Recorder) to automatically shut off after recording is completed, follow steps 1-3 below. OTR lets you quickly specify how long you want a recording to continue. You don't have to program the timer with this function. **You must use your remote control.**

Make sure ...

- the steps in "Hook Up Your VCR" (page 6-7) are done, channels are programmed into the VCR's memory (page 7, 23), and the TV and VCR are both turned on.
- the clock is set to the correct time (page 9).
- the desired tape speed (SP, SLP) is selected. Use the tape SPEED button (page 13).
- the record tab is in place on the cassette (page 5).
- the tape is long enough to record the programs (page 5).

1 Choose a TV Program

Press the VCR CH(annel) UP/DOWN or NUMBER buttons on the remote control.

2 Start an OTR

Press the OTR button on the remote control.

- The screen to the right appears.
- Recording begins immediately.
- OTR will flash on the VCR display.

This indicates that the VCR will automatically shut off after 30 minutes of recording.

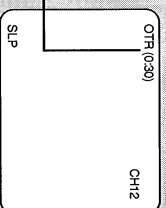

3 Select a Recording Length

Continue pressing the OTR button until the desired recording length is displayed.

- Each press of the button will add 30 minutes, up to 9 hours.
- If pressed beyond 9 hours, "REC" appears on the TV screen.
- To check time remaining after an OTR has been set, press the STATUS button.

To Change the Recording Length

Press the OTR button until the desired length is displayed. The new recording length will then begin.

To Cancel an OTR



To stop recording before the preset recording length is reached, simply press the STOP button. If you want to cancel the OTR mode but continue recording, press the OTR button until the OTR light disappears. "REC" remains on the VCR Display Panel.

- During recording, the displayed time counts down. When 0:00 is reached, recording stops and the power is switched off automatically.
- If OTR is engaged in the Record-Pause mode, the timer will count down normally, but recording will not begin until the PAUSE/STILL button is pressed.

VCR

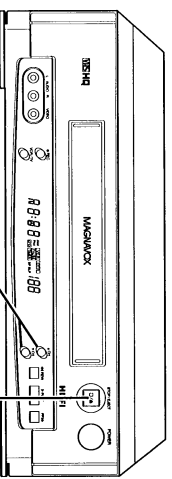

CHANNEL
UP/DOWN
Buttons

STOP
Button

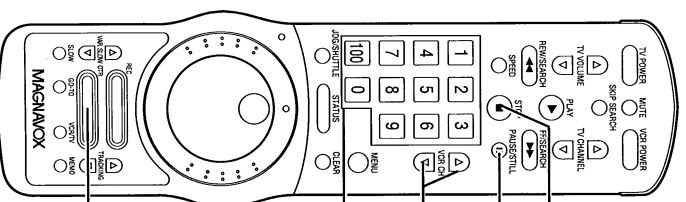

STOP Button

PAUSE/STILL
Button

VCR CH(annel)
UP/DOWN Buttons

NUMBER Buttons

OTR Button

Remote Control

For additional information,
please see page 30.

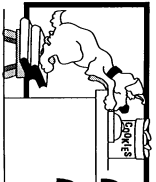

To record while you're away, follow steps 1–12 below. For each event you set, the VCR will turn itself on, do the recording, and turn off automatically. You can store up to eight events. Instructions for each step appear on the TV screen after you begin. **You must use your remote control.**

Make sure ...

- the steps in "Hook Up Your VCR" on pages 6–7 have been completed, an antenna or cable system is connected to the VCR, and the VCR and TV are ON.
- CABLE or NORMAL has been selected and channels have been programmed into the VCR's memory. See "Turn On Your VCR" (page 7) and "Adding/Deleting a Channel" (page 23).
- the VCR/TV button is set to "VCR."

- the clock is set to the correct time (See page 9).
- a cassette tape is inserted in the VCR and the record tab is in place on the cassette (See page 5).
- the tape is long enough to record the programs. **FOR EACH STEP BELOW, YOU HAVE 60 SECONDS TO COMPLETE IT. IF YOU DON'T, PROGRAMMING WILL HAVE TO BE RESTARTED FROM STEP 1.**

VCR

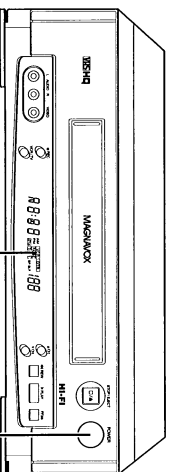

TIMER Light

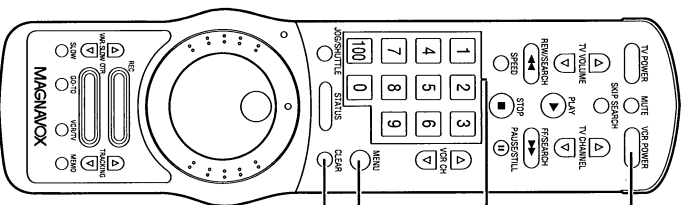

POWER Button

NUMBER Buttons

MENU Button

CLEAR Button

Remote Control

To Make Corrections...

Press the CLEAR button while the screen you wish to change is displayed. This moves the flashing indicator to the number you want to change. Now, enter the correct number. You may have to press the CLEAR button more than once to reach the numbers you want to change.

- 1 Select the Menu Screen**
Press the MENU button on the remote control. The main menu screen at right will appear.

TO SELECT PUSH NO. SHOWN
1 PROGRAM
2 VCR SET UP
3 TUNER SET UP
4 INPUT SELECT
5 CLOCK SET
TO END PUSH MENU

- 2 Select the Program Mode**
Press the NUMBER 1 button on the remote control to select the Program mode.
Remember, use the NUMBER buttons on your remote control.

TO SELECT PUSH NO. SHOWN
1 NORMAL
2 DAILY
3 WEEKLY
4 PROGRAM REVIEW
TO END PUSH MENU

- 3 Select Normal, Daily or Weekly Recording**
Press the 1 button to record a TV show on any day you choose up to 12 months away.

Daily Recording
Press the 2 button to record a TV show every day (Monday through Friday) at the same time and length.

Or

Weekly Recording
Press the 3 button to record a TV show once a week at the same day, time, and length.

TO SELECT PUSH NO. SHOWN
1 NORMAL
2 DAILY
3 WEEKLY
4 PROGRAM REVIEW
TO END PUSH MENU

DAILY PROGRAM (MON-FRI)
PROGRAM-12345678-
PROGRAM-77777777-
SELECT PROGRAM NUMBER
TO END PUSH MENU

WEEKLY PROGRAM
PROGRAM-12345678-
PROGRAM-77777777-
SELECT PROGRAM NUMBER
TO END PUSH MENU

- 4 Select the Event Position**
Press one of NUMBER buttons 1–8 to select one of the 8 event positions to store a timer record program. The flashing numbers indicate an open position where a program can be stored.
• If you select an event position number that has already been set, "PREVIOUSLY SET PROGRAM" appears for a few seconds, then the position contents will be displayed. If this happens, press the MENU button twice and start over.

PREVIOUSLY SET PROGRAM

- 5 Select the Channel**
Enter two numbers for the TV channel. For example, for channel 6, press NUMBER button 0, then 6.
For channels above 100, press the 100 button, then two numbers for the channel. For example, for channel 115, press 100, then press 1 and 5.
To record from line input, press 0 and 0. "AV/IN" will appear on the screen. See page 22.
For recording using a Cable Box, see pages 34–35.

NORMAL PROGRAM CHANNEL
PROGRAM CHANNEL
TO CORRECT PUSH CLEAR

Select the "TIME ON"

6 First, press two NUMBER buttons for the hour.
Next, press two NUMBER buttons for the minute.
Now, press NUMBER button "1" for AM or "2" for PM.
For example, for 9:30 PM, press NUMBER buttons 0-9, 3-0, 2.

```
NORMAL PROGRAM
PROGRAM 1
CHANNEL 10
TIME ON 09:30
TO CORRECT PUSH CLEAR
TO END PUSH MENU
```

Select the "TIME OFF"

7 First, press two NUMBER buttons for the hour.
Next, press two NUMBER buttons for the minute.
For example, for 10:00 PM, press 1-0, 0-0.
Now, press NUMBER button "1" for AM or "2" for PM.

```
NORMAL PROGRAM
PROGRAM 1
CHANNEL 10
TIME ON 10:00
TIME OFF 09:30
TO CORRECT PUSH CLEAR
TO END PUSH MENU
```

Select the Recording Speed

8 Press the 1 or 2 button to choose SP (Standard Play) or SLP (Super Long Play).
You cannot use the SPEED button on the remote control to choose the recording speed.

```
NORMAL PROGRAM
PROGRAM 1
CHANNEL 10
TIME ON 09:30 PM
TIME OFF 10:00 PM
REC SPEED SP
SP = 1 SLP = 2
TO CORRECT PUSH CLEAR
TO END PUSH MENU
```

Select the "START DATE"

9 First, press two NUMBER buttons for the month.
Next, press two NUMBER buttons for the day.
For example, to make a recording on Feb. 12, press 0-2, 1-2.
The year and day of the week will be displayed automatically.

```
NORMAL PROGRAM
PROGRAM 1
CHANNEL 10
TIME ON 09:30 PM
TIME OFF 10:00 PM
REC SPEED SP
START DATE 02/12/93
TO CORRECT PUSH CLEAR
TO END PUSH MENU
```

Confirm Your Program

10 Press the MENU button.
"PROGRAM WAS COMPLETED" should appear on the screen.
If "PROGRAM NOT COMPLETED" appears, please try again from step 1 on page 20.

After 3 seconds, the display will disappear from the screen, and the normal TV program will reappear.
The TIMER light will appear on the VCR.

Select the Next Program

11 If needed, press the MENU button and repeat steps 2 to 10.
When done, go to step 12.

Set the Timer

12 When all programs have been "COMPLETED," press the VCR POWER button to OFF on the remote control. The VCR must be turned OFF to do a Timer Recording.

After a Timer Recording Has Taken Place

Press the POWER button on the remote control to return your VCR (Video Cassette Recorder) to normal operation.

Check or Clear Timer Recordings

1. Turn the VCR on. VCR must be in VCR mode (Page 16).
2. First, press the MENU button.
Next, press the 1 button to select "PROGRAM."
Now, press the 4 button to select "PROGRAM REVIEW."
The Timer Record information for the lowest numbered position (1 - 8) appears.

```
NORMAL PROGRAM
PROGRAM 1
CHANNEL 10
TIME ON 09:30 PM
TIME OFF 10:00 PM
REC SPEED SP
START DATE 02/12/93
FRI
TO CANCEL PUSH CLEAR
NEXT=1 END=MENU
```

3. Press the 1 button repeatedly to view all the filled positions.
If you do not press the 1 button, after 10 seconds the display changes to the next filled position. This continues until all filled positions appear. Finally, the screen returns to the previous on-screen menu.
 4. Press the CLEAR button to clear a filled position.
 5. At any time, press the MENU button once to exit the Program Review mode.
 6. Repeat steps 1 - 4 to make sure you have cleared the correct filled positions. To fill a position, follow "Timer Recording" steps 1 - 12.
- NOTE:** This function does not work with OTR (One Touch Recording).

Stop a Started Timer Recording

1. Press the VCR POWER button.
 - Timer recording is cancelled and VCR power turns off.
- Today's recording stops. If it is a Daily or Weekly recording, future recordings will be carried out as programmed.

If the Power Should Fail...

repeat the steps on pages 7 and 9 before setting up a Timer Recording.

For additional information, please see page 31.

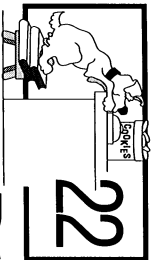

Dubbing from any VHS recorder (or camcorder) to another is simple. Just use the connections and steps below. The example below uses two VCRs like this one. Other VCRs may operate differently. For camcorder output hook ups, see camcorder instruction book.

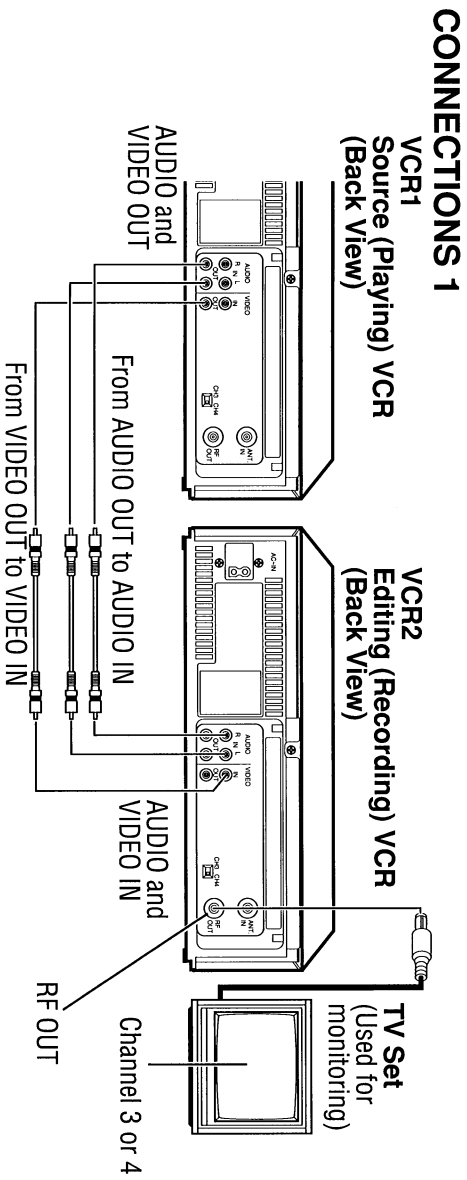

CONNECTIONS 1

CONNECTIONS 2

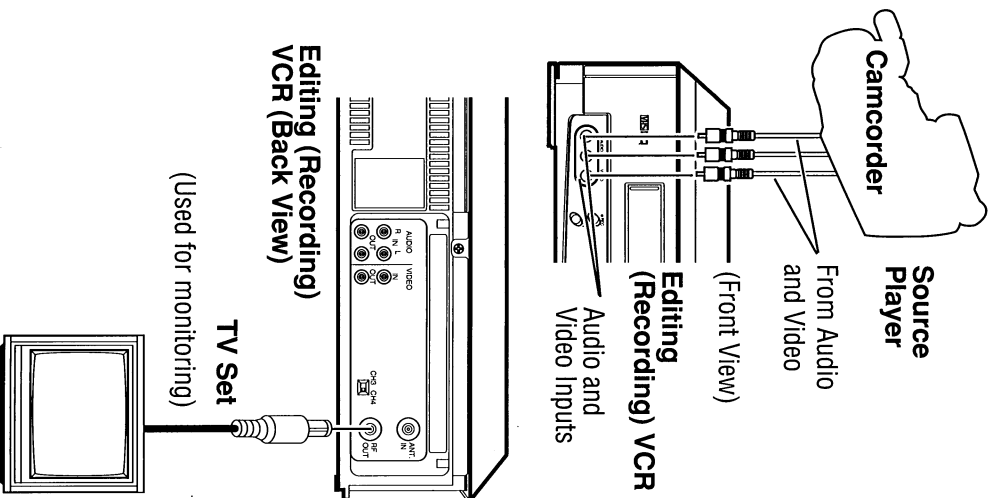

VCR2
Editing (Recording) VCR
(Back View)

TV Set
(Used for monitoring)
Channel 3 or 4

From AUDIO OUT to AUDIO IN
From VIDEO OUT to VIDEO IN

RF OUT

Source Player

From Audio and Video

(Front View)

Editing (Recording) VCR

Audio and Video Inputs

TV Set
(Used for monitoring)

Editing (Recording) VCR (Back View)

1 Insert a pre-recorded tape. VCR 1 is the VCR (Video Cassette Recorder) that will play your tape. If your tape is missing its record tab (page 5), playback starts. In that case, press the STOP button.

At VCR 2

2 Insert a blank tape in the editing VCR. The VCR will turn on automatically. The VCR light on the VCR should come on. If not, press the VCR/TV button on the remote control.

To Monitor the Re-Recording Process On Your TV

3 Turn the TV on.
Turn the TV channel to either 3 or 4, whichever channel VCR 2 is set to (see page 7).

Select Input Source

4 To record from a rear terminal (Connection 1), press the MENU to display the main menu. Press "4" to select the Input Select mode, and then press "2" to select the Rear A/V Input mode. To record from a camcorder terminal (Connection 2), follow the above procedures, but press the "3" button to select the Front A/V Input Mode.

TO SELECT PUSH NO. SHOWN	
1	TUNER
2	A/V IN REAR
3	A/V IN FRONT
(ON)	

"1" appears on the display panel and "A/V IN" on the TV screen.

Select Tape Speed

5 Point your remote control at VCR 2. Press Tape SPEED button to select SP (Standard Play) or SLP (Super Long Play).

Play Back the Tape

6 Press the PLAY button on VCR 1.

Record (Copy) the Tape

7 Press the REC(ord) button on VCR 2. Remember: press the buttons in steps 6 and 7 simultaneously to avoid missing any of the recording.

CAUTION

Unauthorized recording of copyrighted television programs, films, video tapes, and other materials may infringe on the rights of copyright owners and be contrary to copyright laws.

For additional information, please see page 31.

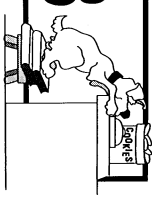

To place receivable channels in your VCR (Video Cassette Recorder), follow steps 1–3 below. Although your VCR automatically scans all TV channels and places receivable ones in memory the first time you turn its power on, this function lets you re-program your VCR's tuner at any time. With the Add/Delete feature you can add or delete any channel. **You must use your remote control.**

Make sure ...

the steps on pages 6–7 have been completed, and your TV and VCR are on.

1 Display the Tuner Set Up Mode

First, press the MENU button to display the main menu screen. Now, press the NUMBER 3 button to select “TUNER SET UP.” The screen at right appears.

TO SELECT PUSH NO. SHOWN

1 TV	[ON]
2 CABLE TV	
3 AUTO PROGRAMMING	
4 ADD/DELETE CH	
5 TV STEREO	
7 END AUDIO	
TO END PUSH MENU	

2 Start Auto Program

Press the NUMBER 3 button to start Auto Programming. “AUTO SET PROCEEDING, PLEASE WAIT” appears on the TV screen.

AUTO SET PROCEEDING
PLEASE WAIT

3 Finish Auto Program

When auto program is complete, “AUTO SET COMPLETED” appears on the TV screen, and then the lowest channel stored in the VCR's memory will appear on the TV screen. To view other stored channels, press the VCR CH(annel) UP/DOWN button. Line mode is always stored in the VCR's memory. “L” appears on the VCR's front panel when selected using the VCR CH(annel) UP/DOWN button.

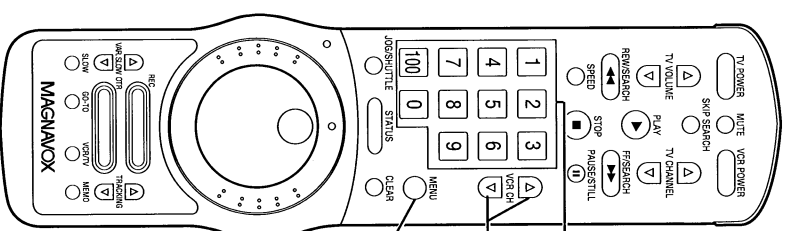

NUMBER Buttons

VCR CH(annel) UP/DOWN Buttons

MENU Button

Remote Control

Adding and Deleting a Channel

1. Press the MENU button to display the menu screen. Next, press the 3 button to select “TUNER SET UP.”
2. Press the 2 button to change from “TV” to “CABLE TV,” to add or delete a cable channel. Press the 1 button to change from “CABLE TV” to “TV,” to add or delete a TV channel. “[ON]” appears beside your selection.
3. Press the 4 button to select the Add/Delete channel feature. The display shown here will appear.
4. Press two numbers to add or delete channels up to 99. For 100 or more, first press the 100 button, then two numbers.
 - Always enter a “0” before any single-digit entries. For example, 0, then 6 for “6.”
 - Refer to “Using the 100 Button” (page 10) to enter a three-digit number.
5. Press the 1, 2, or 3 button to “ADD,” “DELETE,” or “SELECT ANOTHER CH” that is in the VCR's memory.
 - If “3” is selected, the display in step 3 will re-appear.
 - To exit the Add/Delete mode, press the MENU button once.

Note: Channel 0, 0 (Line Input) cannot be added or deleted from the VCR's memory.

SELECT CHANNEL NUMBER
CH -

TO SELECT PUSH NO. SHOWN
CH 12

1 ADD
2 DELETE
3 SELECT ANOTHER CH
TO END PUSH MENU

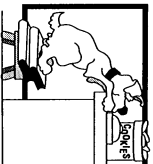

Is your VCR (Video Cassette Recorder) connected to your TV (see page 6-7 "Hook Up Your VCR")? Are you familiar with tape playback (see page 8, "Play a Tape")? If so, you are ready to enjoy the special playback features described on this page. These features work best in the SP (Standard Play) or SLP (Super Long Play) mode. **You must use your remote control.**

To Rapidly Locate a Particular Segment

- 1** First, press the **PLAY** button.
Next, press the **REW(ind)/SEARCH** or **FF (Fast Forward)/SEARCH** button.
A rapid forward or reverse picture search begins.
Search speed in SP mode is about 7 times the normal speed.
Search speed in SLP mode is about 21 times the normal speed.
- 2** Now, press the **PLAY** button to return to playback.
If the **FF** or **REW** button is held down for more than 2 seconds, simply releasing it will cancel the Search mode. In this case, the search speed in SLP mode is about 15 times normal speed.
• During search playback, some noise bars will appear on the TV screen.

To View a Still Picture (During Playback)

- 1** First, press the **PLAY** button.
Next, press the **PAUSE/STILL** button.
A freeze frame (still) playback image appears.
- 2** Now, press the **PAUSE/STILL** or **PLAY** button again to release the still image and continue playback.

To View a Slow Motion Picture

- 1** First, press the **PLAY** button.
Next, press the **SLOW** button.
• During slow motion the slow speed can be controlled using the **VAR(iable) SLOW** button.
- 2** Now, press the **PLAY** or **SLOW** button to release the Slow mode and continue playback.

To View Pictures in Slow to Fast Motion

- 1** First, press the **JOG/SHUTTLE** button while in the Play or Still mode.
- 2** Next, turn the outer ring in either direction.
The farther the ring is rotated, the faster the search speed.
Release the ring stops the picture in the Still mode.
- 3** Next, turn the inner dial in either direction for jog control.
The tape moves forward or backward frame-by-frame at the speed with which the dial is turned.
- 4** Now, press the **PLAY** button to release the Still mode.

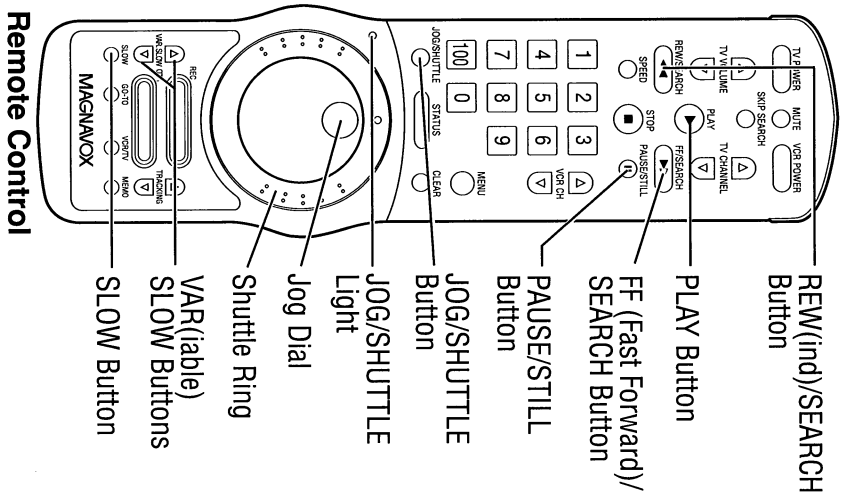

Remote Control



* Slow Motion and Still automatically switch to the Stop mode after 5 minutes to protect the tape and video heads.
* The Jog/Shuttle Light turns off after a 60 second period with no buttons pressed.

Special Playback Features *(cont'd)*



25

Auto Operation Functions

Auto Playback

When a tape is inserted, the power comes on. If the record tab* is removed, playback begins.

Auto Rewind

When a tape reaches its end during playback, fast forward, or manual record, the VCR rewinds the tape and goes into Stop mode.

Memory Rewind Power Off

When the POWER button is pressed during rewind, the VCR will turn off after rewind is complete.

REWIND → POWER OFF appears on the screen.

Eject Cassette

A cassette may be ejected with power on or off.

* For record tab information, refer to page 5.

Auto Tracking Control

With Auto Tracking there is usually no need for manual adjustments to minimize noise in playback for most tapes. Auto Tracking continuously analyzes the signal to adjust for optimum picture quality for each recording. However, with some recordings you may get a better result using the TRACKING UP/DOWN buttons.

Manual Tracking Controls

Press the TRACKING UP/DOWN button.

Use Manual Tracking adjustment during playback and slow motion to minimize noise in the picture.

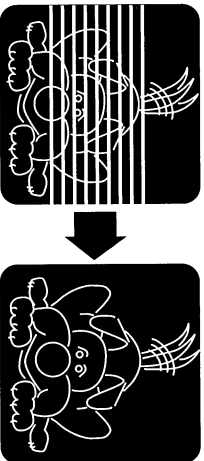

Also, use these buttons to reduce jitter in a still picture. Once you make this adjustment, you probably will not have to do it again – unless you select Still mode while playing a tape recorded on a different VCR.

To cancel manual tracking, stop the tape, eject the tape, then re-insert it. Each time a tape is inserted automatic tracking is engaged. You can also cancel manual tracking by simultaneously pressing the VCR's CH(annel) Up and CH. Down buttons.

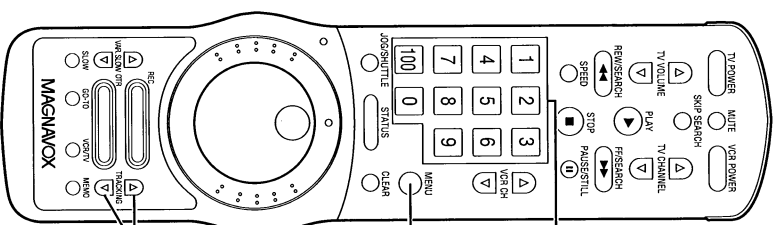

NUMBER Buttons

MENU Button

TRACKING UP/DOWN Buttons

Remote Control

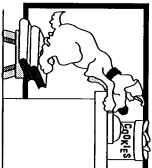

Your VCR (Video Cassette Recorder) can record and play back a second audio program (SAP or "2ND AUDIO") or TV stereo when received as an MTS broadcast.

MTS Recording and Playback

By hooking-up to a stereo amplifier and speakers, you can enjoy MTS broadcasts. You can select the type of broadcast and sound track you wish to record or play back using steps 1 – 4 below.

Make sure...

- an antenna or cable system is connected to the VCR (pages 6–7).
- a cassette is inserted (page 5).
- the desired tape speed (SP, SLP) is selected (page 13).

CONNECTIONS

Note:

- Input hook ups to the VCR not shown. See pages 6–7.
- For connections to the TV using Audio/Video Outputs, the TV may have to be in the AUX mode. See TV instruction book.

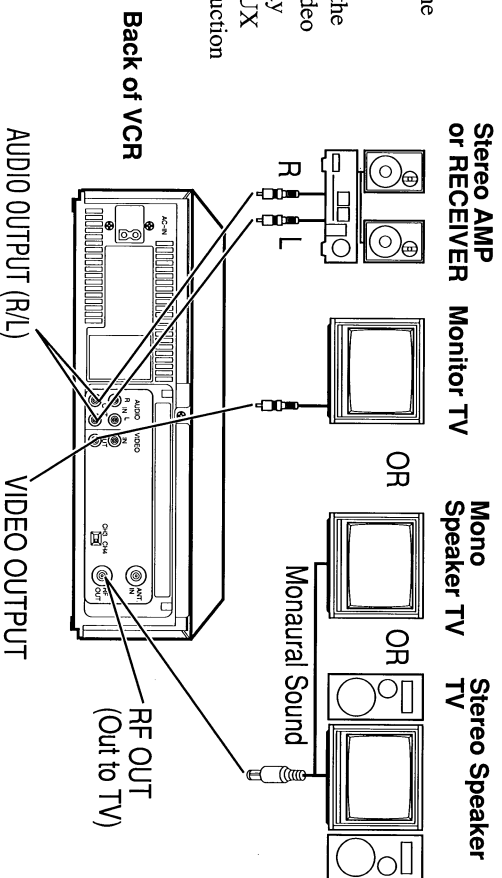

Remote Control

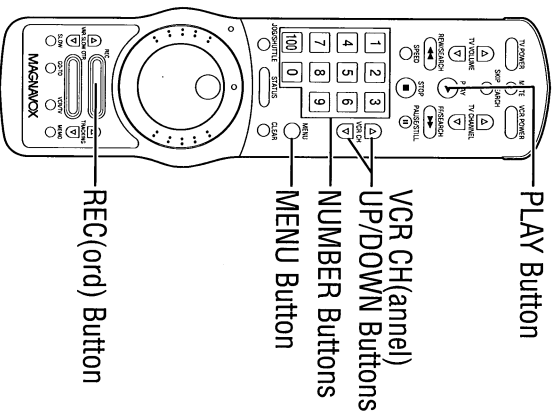

Choose Input Source

- 1** (You may skip this step if "TUNER" is already selected.) First, press the MENU button. Next, press the 4 button to select "INPUT SELECT". Then, press the 1 button to select "TUNER." Now, press the MENU button to leave this mode.

Choose a Program

- 2** (Select the type of broadcast.) First, press the MENU button. Next, press the 3 button. The "TUNER SET UP" menu appears. Then, press the 6 button for "TV STEREO," or the 7 button for "2ND AUDIO." Make the desired selection according to the type of broadcast. This selects which type of audio programs are recorded on the tape. Now, press the MENU button to leave this mode.

To Playback

- 2a** To playback, press the PLAY button. To record, go to step 3.

Choose the Channel

- 3** Select the channel to be recorded using the VCR CH(annel) UP/DOWN or NUMBER buttons.

Start Recording

- 4** Press the REC(ord) button.

For additional information, please see page 30.

MTS:

means a Multi-Channel Television Sound broadcast.

Hi-Fi Stereo:

records and plays back on the Left and Right Hi-Fi tracks.

SAP or 2ND AUDIO:

means Second Audio Program possibly recorded in a second language.

VHS Hi-Fi Stereo Sound System

27

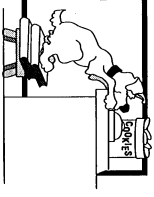

When an MTS program is broadcast in Hi-Fi stereo, it will automatically be recorded in Hi-Fi stereo. To playback, just be sure the settings shown in the TUNER SET UP and AUDIO OUT menus are displayed like those below. With these settings, you can playback stereo programs in Hi-Fi audio.

MTS (Multi-Channel Television) Hi-Fi Playback

When you want to playback an MTS broadcast, be sure the VCR is connected to a Stereo AMP or Receiver, or a stereo TV (as shown on page 26, see "Connections"), and the settings described in steps 1-3 below have been made.

Choose Input Source

1 (You may skip this step if "TUNER" is already selected.)

First, press the MENU button.
Next, press the 4 button to select "INPUT SELECT."
Then, press the 1 button to select "TUNER."
Now, press the MENU button to leave this mode.

TO SELECT PUSH NO. SHOWN
1 PROGRAM
2 VCR SET UP
3 TUNER SET UP
4 INPUT SELECT
5 CLOCK SET
TO END PUSH MENU

OSD Main Menu

TO SELECT PUSH NO. SHOWN (ON)
1 TUNER
2 AV IN REAR
3 AV IN FRONT
TO END PUSH MENU

INPUT SELECT Menu

Selecting Hi-Fi Output Mode

(Select "HI-FI" from the AUDIO OUT menu.)

2 First, press the MENU button.
Next, press the 2 button.
The "VCR SET UP" menu appears.
Then, press the 2 button.
The "AUDIO OUT" menu appears.
Now, press the 1 button.
This setting gives you:
• stereo Hi-Fi playback
• monaural playback of non Hi-Fi tapes.

TO SELECT PUSH NO. SHOWN (ON)
1 HI-FI
2 MONO
TO END PUSH MENU

AUDIO OUT Menu



Normally "HI-FI" should be selected from the AUDIO OUT menu for playback with Hi-Fi sound. But you can change the selection to "MONO" to listen to the monaural audio playback, for example, of an audio dubbed tape.

Select TV STEREO or 2ND AUDIO Mode

3 First, press the MENU button.
Next, press the 3 button.
The "TUNER SET UP" menu appears.
a) Now, press the 6 button to select "TV STEREO."
This setting plays back:
• stereo Hi-Fi recording (in the main language).
Or
b) Now, press the 7 button to select "2ND AUDIO."
This setting plays back:
• recordings in the Second Audio language.

TO SELECT PUSH NO. SHOWN
1 TV
2 CABLE TV
3 AUTO PROGRAMMING
4 ADD/DELETE CH
5 CH MEMORY REVIEW
6 TV STEREO
7 2ND AUDIO
TO END PUSH MENU

TUNER SET UP Menu

To Clear the On Screen Display

Press the MENU button.

Recording in VHS Hi-Fi

Both the Hi-Fi audio and the separate linear (monaural) audio are automatically recorded on their respective tracks.

Note: To record, a video signal is required for proper speed accuracy.

For additional information,
please see page 30.

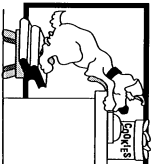

Tape Counter Control

If you always rewind your tapes fully and reset the tape counter, then you'll be able to use a list of program locations as an index. **You must use your remote control.**

Select the Tape Counter Display

- 1 To select the tape counter display, press the **STATUS** button. The tape counter display appears on the TV screen.

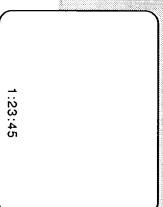

Reset the Tape Counter

- 2 To reset the tape counter, press the **CLEAR** button. You can reset the counter to zero at whatever point on the tape you choose.

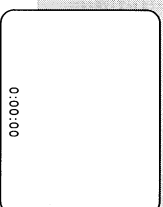

Select the Memory Function

- 3 To select the memory function, press the **MEMO(ry)** button. "M" will appear on the screen.

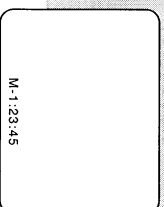

Start the Memory Function

- 4 To start the memory function, from anywhere on the tape, press the **STOP** button, then press the **REW(ind)** or **FF (Fast Forward)** button. The tape will stop automatically wherever "0:00:00" was set.

Remote Control

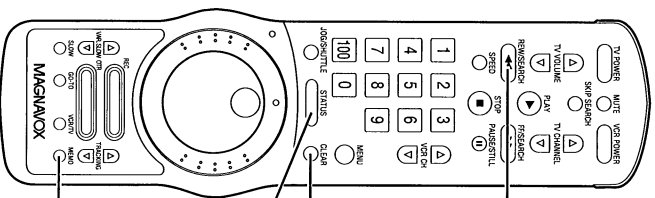

Go-To Function

You can have your VCR automatically "go to" and locate the point on the tape with the counter reading that you specify. **You must use your remote control.**

Select the Go-To Function

- 1 While in the Stop mode, press the **GO-TO** button. The screen at right appears.

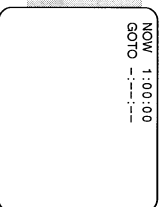

Select the Counter Number

- 2 Select the desired counter number by pressing the **NUMBER** buttons. For example, by pressing 1, 2-0, 0-0, the VCR will automatically go to the point with counter reading "1:20:00." If the counter location you want has a minus (-) before it, you can enter the minus by pressing the **VCR CH(annel) DOWN** button. To remove the minus, press the **VCR CH(annel) UP** button.

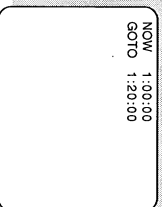

Start the Go-To Function

- 3 Press the **PLAY** or **REC** or **STOP** or **VCR POWER** button. The Go-To function will Fast Forward or Rewind to the counter number, and depending on which button you pressed, will enter that mode. **PLAY** button = Will begin playback at that point. **REC** button = Will begin recording at that point. **STOP** button = Will stop at that point. **VCR POWER** button = Will turn the VCR's power off at that point.

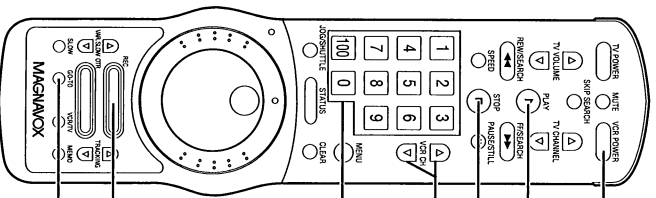
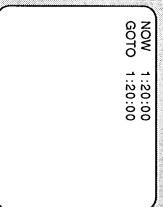

Remote Control

TV Code Setting

29

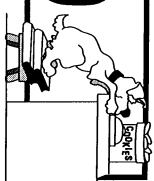

Your remote control may be able to operate the basic functions of your television. In addition to MAGNAVOX televisions, other manufacturer's televisions listed below can also be controlled by setting the remote control to the corresponding TV code. Initially, the code number is set to 01.

Try your Remote Control

- 1 Point this remote control at your remote controllable TV and try the TV POWER button. If it turns your TV on and off, try the other buttons.
If these buttons do not work your TV, go to step 2.

To set the TV Code

- 2 While pressing the TV POWER button, also press the NUMBER buttons for the code number of your TV's brand listed below. For example, press 0, then 2 for code 02. Now, repeat step 1.
If the remote still does not work your TV, use another code and repeat step 2.

Whenever you replace batteries

...in the remote control, it is necessary to re-set the TV code if your television is not a MAGNAVOX TV.



Important

Although the provided remote control unit is compatible with most MAGNAVOX televisions, as well as many TV models manufactured by others, it is possible that the provided remote control will not work with your TV, or in some instances, will have limited capability.

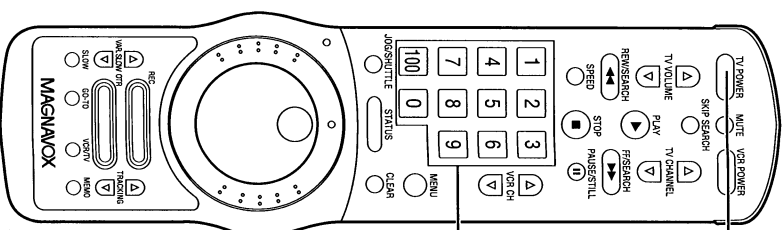

TV POWER Button

NUMBER Buttons

Remote Control

TV BRAND NAME	CODE	TV BRAND NAME	CODE	TV BRAND NAME	CODE	TV BRAND NAME	CODE
MAGNAVOX	01	FISHER	11	MARANTZ	05	RADIO SHACK	06
MAGNAVOX	02	GENERAL ELECTRIC	07	MARANTZ	13	RADIO SHACK	14
MAGNAVOX	03	GENERAL ELECTRIC	10	MGA/MITSUBISHI	03	RCA	05
		GOLDSTAR	02	MGA/MITSUBISHI	05	RCA	10
AKAI	05	GOLDSTAR	05	MGA/MITSUBISHI	13	SAMPO	03
AOC	05	HITACHI	02	NEC	03	SANYO	11
CENTURION	03	HITACHI	12	NEC	05	SCOTT	03
CORONADO	02	J.C. PENNEY	03	PANASONIC	07	SEARS	08
CURTIS-MATHES	03	J.C. PENNEY	05	PHILCO	02	SEARS	11
DAY TRON	03	JVC	04	PHILCO	05	SHARP	02
EMERSON	02	KWC	02	PHILIPS	01	SHARP	06
EMERSON	05	KTV	02	PORTLAND	02	SHARP	16
EMERSON	14	KTV	05	QUASAR	07	SONY	09

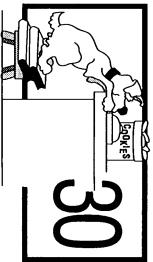

30

Notes on Operations

Hook Up Your VCR

- If the reception on all VHF (Very High Frequency) channels is unsatisfactory, you may need to re-tune your TV set.

Clock Adjustment

- In the Clock Adjustment mode, be sure to enter the first digit and all subsequent entries within 10 seconds of one another. Otherwise, the VCR will automatically leave this mode and the program you were watching will return to the screen. If this happens, press the MENU button and start again.
- Be sure to enter "0" before single-digit numbers.
- The letters indicating the day of the week will appear when you have entered both digits for the year.
- If the digits entered for the month or day do not match the calendar, the entry will be rejected and "?" will appear.
- If you press the MENU button while in the Clock Set mode, the TV screen will return to the program you were watching.
- Once a Timer Recording has been set, you cannot reset the clock. To change the clock's time, first cancel Timer Recording(s).

Special Playback Features

- During search playback, horizontal noise bars will appear on the TV screen.
- After the VCR has been in the Still mode for 5 minutes, it will automatically go to the Stop mode to protect the tape and video heads.
- Special-effects playback can be used during playback of tapes recorded in the SP or SLP mode. Tapes recorded in the LP mode cannot be viewed in special-effects playback.

To Record

- Although it is possible to change the tape speed while you are recording, some distortion will appear on the tape at the point where you make the change.
- After the VCR has been in the Pause mode for 5 minutes, it will automatically go to the Stop mode to protect the tape and video heads.

One Touch Recording (OTR)

- If the preset time for a timer recording comes up during OTR recording, OTR has priority.

VHS Hi-Fi Stereo Sound System

- A difference in audio level may be detected between Hi-Fi and normal audio playback.
- While adjusting tracking control, Hi-Fi audio sound may revert to normal audio sound. This is normal.
- To record audio, a video signal is required for proper speed accuracy.
- When you hook the audio output jacks on your VCR to the audio input jacks on your stereo TV, the stereo light on the TV might not glow. This is normal. As long as your VCR indicates a stereo signal and the correct connections made (see page 35), you are receiving a stereo signal.
- When connecting this VCR to a stereo TV, you will only get stereo sound on your TV if you use audio cables and connect the VCR's audio output jacks to the stereo TV's audio input jacks and the TV is switched to the Line (or AUXiliary) Input.
- If the Hi-Fi sound keeps reverting to normal (monaural) sound during playback, you may want to change "AUDIO OUT" to "MONO," see page 27, step 2.
- Only Hi-Fi stereo tapes will play back in the Hi-Fi stereo mode. Tapes with standard stereo sound will play back in monaural sound.
- If using the VCR to select channels to watch on TV (using the VCR as the TV channel tuner), select "TV STEREO" under "TUNER SETUP" menu. This allows you to hear stereo sound from channels broadcasting in stereo.

MTS (Multi-Channel Television) Broadcast Stereo System

- When stereo or second audio program is recorded on this VCR and played back on a conventional VHS VCR, the playback sound will be from the normal sound track.
- Once 2ND AUDIO is selected, if no 2ND AUDIO is available, the VCR reverts to non-2ND AUDIO (normal) audio.
- If using the VCR to select channels to receive 2ND AUDIO (SAP) and watch on TV (using the VCR as the TV channel tuner), select "2ND AUDIO" under "TUNER SETUP" menu. This allows you to hear 2ND AUDIO from channels broadcasting in 2ND AUDIO.



Timer Recording

- To do a timer recording in the LINE mode, follow steps 1 – 4 in “Timer Recording” section. At step 5, press the NUMBER button 0 twice (0, 0) to engage the “LINE” (external source) mode. Complete the rest of the steps under “Timer Recording” section.
- Timer recording may not be performed or continued if a power interruption of more than one minute occurs before or during timer recording; even if power resumes thereafter. Preset clock and timer data will be lost. This is indicated by the clock display on the VCR which resets to “- : - : - ?”. If this happens, reset the clock and program the timer.
- If the time spans of two preset programs overlap, the lower-numbered program will have priority and the second program will start only after the first program has been executed.
- If the POWER button is pressed to OFF with no cassette loaded, the TIMER and “Cassette Inside” indicators will continue blinking.
- If the record tab is missing, the cassette will be ejected when the POWER button is pressed to OFF, and the TIMER and “Cassette Inside” lights will continue blinking.
- 12 PM = Noon
- 12 AM = Midnight
- Once a Timer Recording has been set, you cannot change from (Normal) TV to Cable TV or Cable TV to TV. You must first cancel Timer Recording(s).
- You should finish a Timer Recording at least 5 minutes before the recording is set to start.

Power Failure

- Timer Recordings will be erased if the power fails. Repeat “Set the Clock” on page 9 before setting up a “Timer Recording” on pages 20–21.

Satellite Hook-Up

- Watching one TV channel while recording another may not be possible with a satellite hook-up.
- You may have to set your VCR to channel 3 or 4 and make your channel selections at the satellite converter box.
- For many satellite hook ups, if you use accessory Audio and Video cables (not supplied) to hook up your VCR to your TV, you will have to set your VCR to Line Input. “A/V IN” appears on your TV screen when you first switch into this mode. “L” appears on your VCR. The VCR to TV hook-up will look similar to “Stereo VCR to Stereo TV Hook-Ups” on page 35. For details, see your satellite hook up instructions.

Line Input

- If you accidentally get into the Line mode (“L” appears on the VCR), to exit simply press the VCR CH(annel) UP/DOWN button or select a channel using the NUMBER buttons.
- Pressing “O, O” puts you in Line mode (“L” appears on the VCR). If “A/V IN FRONT” is selected under the “INPUT SELECT” screen, “O, O” will always make the audio and video jacks in the front of the VCR active. If “A/V IN REAR” is selected, the rear audio and video jacks will be active.

Specifications

Video Recording System	Rotary four-head helical scan system
Video Signal	EIA standards: NTSC color VHF/UHF – 75 ohm external antenna terminal
VHF Output Signal	Channel 3 or 4 (switchable) 75 ohms unbalanced
Power Requirement	120 V AC ~ 60 Hz
Power Consumption	19W
Operating Temperature	41°F (5°C) to 104°F (40°C)
Relative Humidity	10% to 80%
Weight	9.5 lbs. (4.3 kg)
Dimensions	14-3/16"(W) x 3-3/4"(H) x 12"(D) (360 mm x 94 mm x 304 mm)
Tuner	VHF 2 – 13, UHF 14 – 69
Broadcast Channels	Midband A – I
CATV Channels	Superband J – W
	Hypersband A-5 – A-1
	Special channel 5A
	Ultraband 37 – 94, 100 – 125

Design and specifications are subject to change without notice.

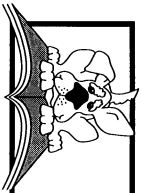

Antenna or Cable to VCR to TV Connections

- STEP 1: Disconnect the Antenna or Cable from Your TV.** **STEP 2: Connect Your Antenna or Cable to Your VCR.**

Your antenna or cable should have one of the ends shown below. To avoid confusion, label all terminals (on TV) and ends before disconnecting.

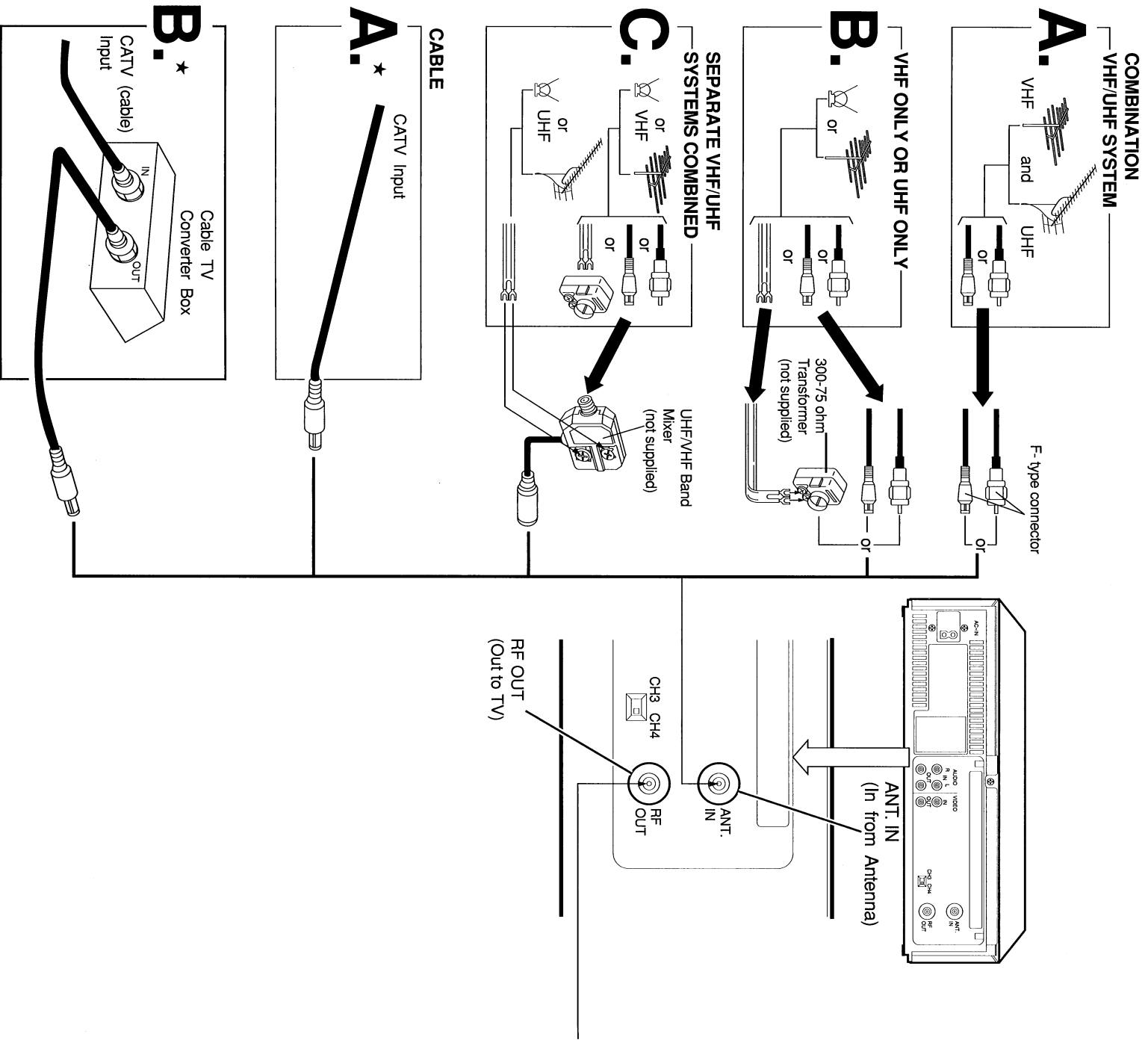

* Please see pages 34 – 35 for details.



STEP 3: Connect Your VCR to Your TV.

Look at the back panel of your TV. Find the appropriate diagram below and use that method to connect your VCR to your TV. Use only one connection.

STEP 4: Select Channel 3 or 4.

For details, see pages 7 and 34-35.

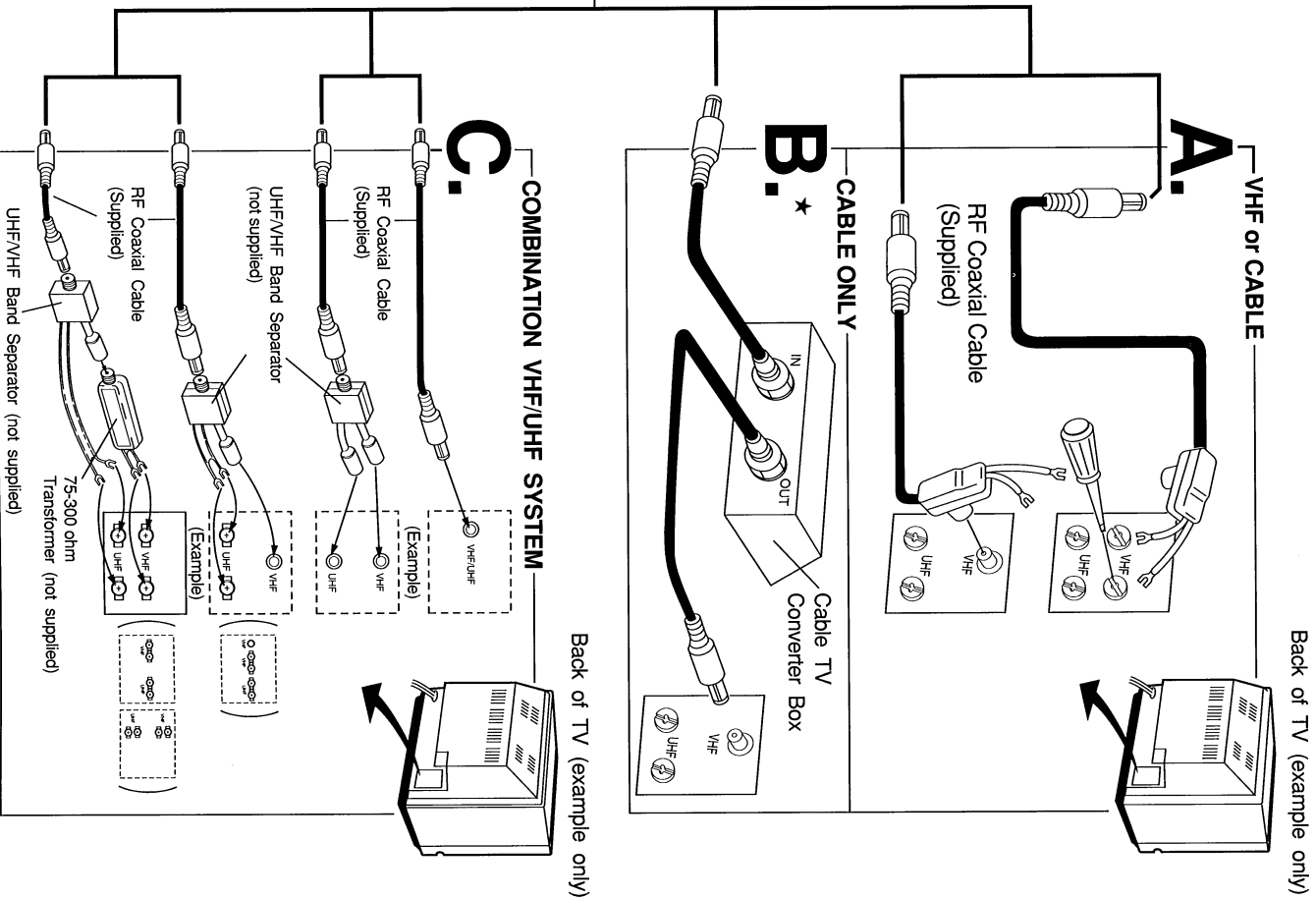

For UHF-ONLY antenna system:
Even if you plan to only play back tapes or view and record UHF programs, you still need to make one of the combination VHF/UHF connections shown above, because when in operation, your VCR sends VHF signals (either channel 3 or 4) to the TV across the RF Coaxial Cable.

* Please see pages 34 - 35 for details.

Without a Converter/Descrambler Box

Use this connection if your cable system connects directly to your TV without a converter box.

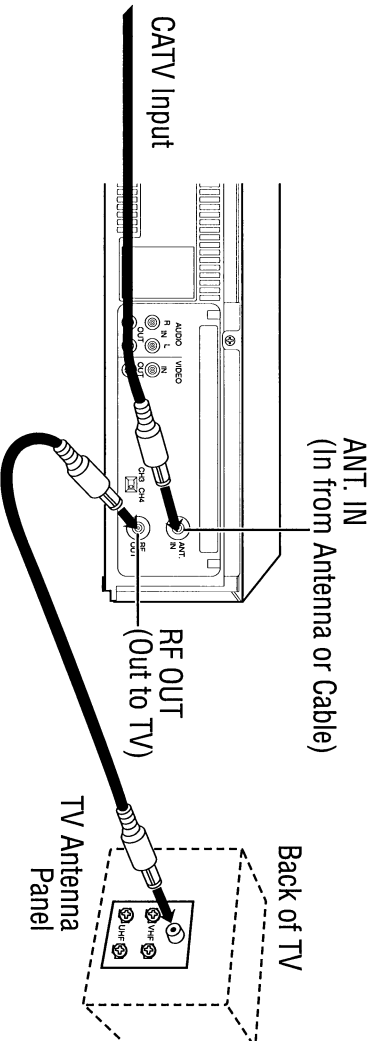

With this connection, you can: (1) use your VCR Remote Control to select channels; (2) program one or more unscrambled channels for unattended recording; (3) view one channel while recording another.

NOTE: • You can also use the VCR CHANNEL UP/DOWN button to select the desired channel.

- You cannot record or view scrambled channels with this connection.

With a (Cable to VCR) Converter/Descrambler Box

If your cable service supplies you with a converter box, you can use the basic connection shown here.

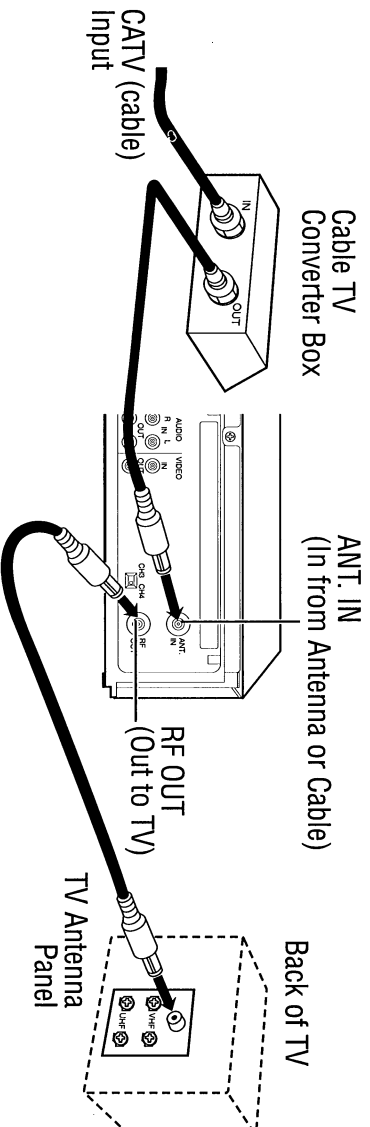

With this connection, you can record and view any channel including scrambled channels. However, channel selection must be made at the cable company converter box. This means that channels cannot be changed using the VCR Remote Control. Unattended recording is limited to one channel at a time, and you cannot view any channel than the one you are recording.

To Record and View a Scrambled/Unscrambled Channel

1. Turn the VCR on and, if needed, set the VCR/TV button located on the front of the VCR to "VCR" (VCR light will shine).
2. Set the VCR channel to the output channel of the Cable Converter Box. (If the Cable Converter Box is set to channel 3, the VCR should be set to channel 3. If the Box is set to channel 4, the VCR should be set to channel 4).
3. Set the TV channel to the output channel of the VCR (channel 3 or 4).
4. Select the channel to be recorded at the Cable Converter Box.

NOTE: To do a Timer Recording or One Touch Recording (OTR) using this hook up, select the channel to be recorded at the Cable Converter Box. Leave the VCR on channel 3 or 4 (see step 2 above). Follow all other Timer Recording and OTR instructions. Remember, the Cable Converter Box must be on at the time of the recording.

To Watch TV (with the VCR off)

1. Set the TV channel selector to the output channel of the Cable Converter Box.
2. Select the channel on the cable converter channel selector.

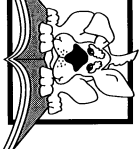

With a (VCR to TV) Converter/Descrambler Box

If your cable system uses a converter box, you may try this connection instead of the basic cable connection shown on the previous page.

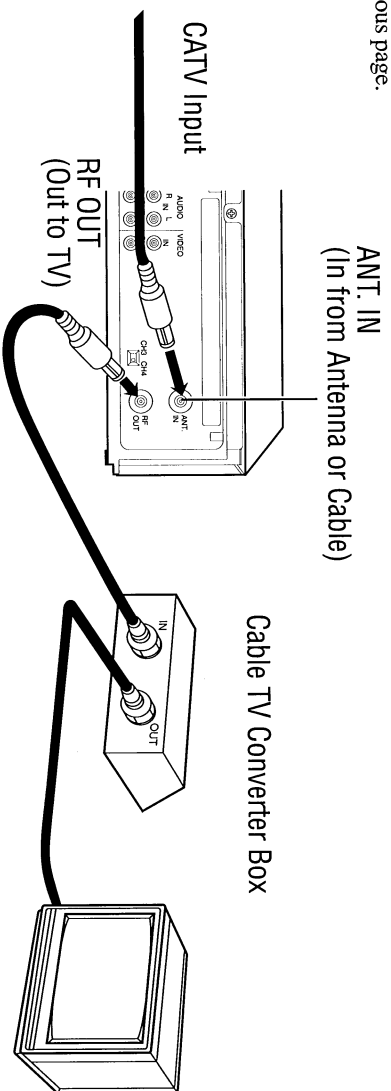

With this connection, you can: (1) program unattended recording of more than one unscrambled channel; (2) view one channel while recording another.

NOTE: • Use the VCR CHANNEL UP/DOWN button to select the channel to be recorded, including Timer Recording and One Touch Recording.
• You cannot record scrambled channels with this connection.

To Record One Channel While Viewing Another

1. Select the channel to be recorded with the VCR CHANNEL UP/DOWN button.
2. On the VCR set the VCR/TV button to "TV."
3. Set the channel selector on the TV to the output channel of the Converter Box.
4. Select the channel to be viewed on the Converter Box.

To Play Back a Tape

1. Set the VCR/TV button to "VCR."
2. Set the TV channel selector to the output channel of the Converter Box.
3. Set the Converter Box channel selector to the VCR output channel (channel 3 or 4).

Stereo VCR to Stereo TV Hook-Ups

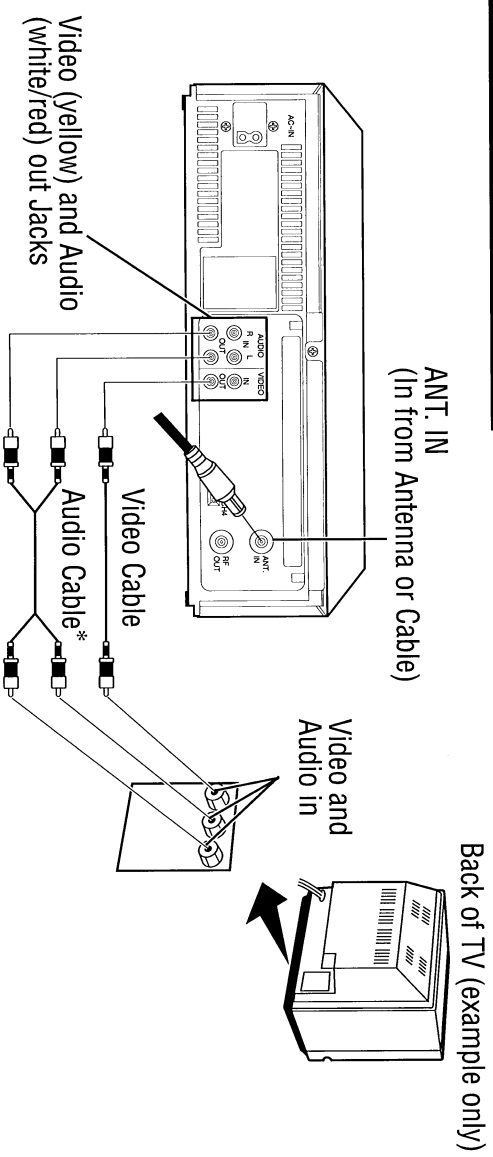

* A stereo audio cable (not supplied) is used here to deliver audio to the TV's Left and Right channels. For any additional adjustments you may need to make to your TV, please refer to your TV owner's manual. Cables not included.

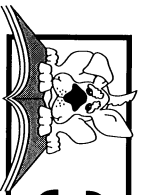

IMPORTANT NOTE: Periodic maintenance is required in order to maintain the unit's continued excellent performance. After a period of time the Video heads will require replacement. If cleaning or replacement of the Video heads is required, this service should be performed by an authorized Video System Service Center.

Check the following points once again if you are having some difficulty with your VCR (Video Cassette Recorder).

<p>Power</p> <p>No power...</p> <p>Power Failure...</p>	<p>Correction</p> <ul style="list-style-type: none"> • Check that the Power plug is completely connected both to the VCR and to an AC (Alternating Current) outlet. • Check that the Power button is set to on. • Please complete "Setting the Clock" on page 9 before attempting to set up a "Timer Recording" on page 20 – 21.
<p>Recording & Playback</p> <p>TV program can't be recorded...</p> <p>Timer recording can't be performed...</p> <p>There is no playback picture, or the playback picture is noisy or contains streaks...</p>	<p>Correction</p> <ul style="list-style-type: none"> • Check the connections between the VCR, the external antenna, and your TV. • Check that the band selected matches your antenna or cable TV system (P.32 – 35). • Make sure that the record tab on the back of the cassette is still intact. (P.5). • Set the recording start/stop time correctly (P.20 – 21). • Make sure that the POWER button is set to "OFF" (P.21). • Timer recording may not be performed or continued if a power interruption of more than 1 minute occurs before or during Timer Recording, even if the power resumes thereafter. • Select the same channel on your TV as that of the VCR Channel 3/4 switch (P.7). • Set the VCR/TV button to "VCR" (P.12 or 16). • Check that channel 3 or 4 of the TV is properly adjusted. • Adjust the Tracking control slowly in either direction (P.25).
<p>During special effects playback, the picture may contain some vertical jitter when using a TV which has an Automatic Vertical Hold Control...</p> <p>If the top of your playback picture waves back and forth excessively...</p>	<p>Correction</p> <ul style="list-style-type: none"> • Because the VCR playback signal is not as stable as an off-the-air TV signal, the top of your TV screen may be bent or unstable during playback. To solve this problem, slowly turn the HORIZONTAL HOLD control on your TV to correct the wavy picture. If your TV does not have the horizontal hold control or adjusting the control does not help, please contact your local TV service center.
<p>Remote Control</p> <p>VCR can't be remote controlled...</p>	<p>Correction</p> <ul style="list-style-type: none"> • Aim the Remote Control directly at the remote sensor on the VCR. (P.15) • Avoid all obstacles which may interfere with the signal path. • Inspect or replace the batteries (P.5). • Make sure batteries are inserted correctly (P.5). • VCR is in Antenna (TV) mode (P.8 and 23).
<p>Miscellaneous</p> <p>Number buttons won't work for channels above 69...</p> <p>You can't view programs normally on the TV...</p> <p>Video cassette can't be inserted...</p> <p>Video cassette can't be removed...</p> <p>Video cassette ejects when the OTR or RECORD button is pressed or the POWER button is pressed off to set the Timer...</p> <p>In the Stop mode, the motor (CYLINDER) continues to rotate...</p> <p>If you cannot receive channels above 13...</p>	<p>Correction</p> <ul style="list-style-type: none"> • Set the VCR/TV button to "TV" (P.12 or 16). • Check VCR Hookup (p. 6-7 or 32-35) • Insert the cassette with the window side up and the record tab facing you. • Make sure a cassette tape is not already inserted. Press STOP/EJECT button on VCR. • Check that the power plug is completely connected to an AC outlet. • Check the cassette to be sure that the record tab on the back of the cassette is still intact (P.5). • To enable quick play mechanism the cylinder will rotate for about 5 minutes. This is normal. • Follow "Special VCR Features" on page 23. Then select "TUNER SET UP" menu and see if "ON" is beside "CABLE TV".



LIMITED WARRANTY

Video Cassette Recorder/Player

- 90-Day Carry-In Service Labor Warranty
- One (1) Year Exchange Warranty On Parts

For purchases outside the U.S.A., see applicable warranty from country of purchase.

Please keep...

...your sales receipt and other material proving proof-of-purchase. Attach it to this owner's manual and keep both nearby. Please also keep the original box and packing material. And please write in your model and serial numbers in the shaded area below.

Parts and Labor Coverage...

...starts from the date you bought your product. For the first 90 days both parts and labor are covered. After 90 days, only parts are covered for the remainder of one (1) year. Any defective part will be repaired or replaced. Any part is covered only for the original warranty period. Once the one (1) year warranty on the product has expired, the warranty on any replaced or repaired part also expires. Service is provided by a Philips Factory Service Center or an Authorized Service Center. Centers must be allowed to keep defective parts.

After 90 days, you pay for all labor. **After one year**, you pay for all parts, transportation, and service charges too.

Who is Protected? ...Where?

Only the person who has proof-of-purchase will receive warranty service. This service will be provided to any product bought and used in the U.S.A., Puerto Rico, and the Virgin Islands. If you move within these areas, any Philips Factory Service Center (See enclosed list.) or an Authorized Service Center in your area will honor this warranty.

Before Calling for Service...

...*please check your owner's manual.* A check of the controls discussed there may save you a service call.

How to Get Warranty Service:

If warranty service is required, you must deliver your product with proof-of-purchase to a Philips Factory Service Center (See enclosed list.) or Authorized Service Center for repair. When repair is completed, you must pick up the unit at the Center.

Please write in your model and serial numbers below. These numbers are located on your product. Keep this manual nearby for easy reference.

Model No.: _____

Serial No.: _____

Warranty Exclusions –

Your Warranty Does Not Cover...

...**labor charges** for installation or set up, adjustment of customer or preference controls, and installation or repair of antenna systems outside the unit.

...**product repair** and/or part replacement because of misuse, accident, unauthorized repair or other cause not within the control of Philips Consumer Electronics Company.

...**reception problems** caused by signal conditions or cable or antenna systems outside the unit.

...**a product purchased**, used, or serviced outside the U.S.A., Puerto Rico, and the Virgin Islands, or used for commercial or institutional purposes (including but not limited to products used for rental purposes).

...**incidental or consequential damages** resulting from the product. Some states do not allow the exclusion of incidental or consequential damages, so the above exclusion may not apply to you. This includes, but is not limited to, pre-recorded material (copyright or non-copyright).

ALL IMPLIED WARRANTIES, INCLUDING IMPLIED WARRANTIES OF MERCHANTABILITY AND FITNESS FOR A PARTICULAR PURPOSE, ARE LIMITED IN DURATION TO THE DURATION OF THIS EXPRESS WARRANTY. Some states do not allow limitations on how long an implied warranty lasts, so the above limitation may not apply to you.

This warranty gives you specific legal rights. You may have other rights which vary from state to state.

Cassette Tapes

It is recommended that you use only cassette tapes which have been tested and inspected for use in 2, 4, 6, or 8 hour VHS recorders, and which are so labeled. The use of tapes which have not been tested nor of a VHS format may result in poor picture quality. Damage caused by the use of tapes other than those recommended may void the product warranty.

IMPORTANT REMINDER:

Please fill out and mail your warranty/registration card promptly. It will be easier for us to notify you if it should ever be required. Please also keep your sales receipt and other proof-of-purchase information.

Philips Service Company

401 East Old Andrew Johnson Hwy. • Jefferson City, Tennessee 37760
(615) 475-8869

PLEASE HAVE YOUR MODEL AND SERIAL NUMBERS ON HAND ANY TIME YOU CALL.



For your convenience, the following list of terms is provided to help you better understand your VCR and its operation.

AUDIO IN/OUT: These are connectors (jacks) located on the back of the unit. They are used to record the audio from another source (IN) or play the audio to another source (OUT).

AUTO PROGRAM: This is part of the CHANNEL MEMORY function. When used the VCR runs through (scans) all the channels on the VCR and all the channels received in your area are automatically placed in memory.

TV BANDS: Two possible settings:

TV CH (TV or Normal TV)

This consists of two types of frequencies:

VHF

(Very High Frequency) Channels which are received by the tuner on channels 2 to 13.

UHF

(Ultra High Frequency) Channels which are received by the tuner on channels 14 to 69.

CATV (Cable TV)

CABLE TV, the second setting possible for TV Band tuning. This term means the unit is capable of receiving standard and unscrambled channels on cable without the use of a cable decoder or converter box.

CHANNEL(S): Selected with the NUMBER buttons or CHANNEL UP & DOWN buttons on the remote.

CLEAR: To remove a completely programmed Timer Recording or to correct a single clock or program entry.

COUNTER: For locating specific areas on a tape by referencing the counter number.

DUBBING: Copying the contents of a tape with the use of a second VCR.

EXIT: To quit a specific task as directed by your operating instructions on screen or in the book.

FAST FORWARD (FF ►►): To move the tape rapidly in the forward direction.

FRAME: Single still picture.

HQ (High Quality): An enhancement feature in the VCR circuitry which provides greater picture detail.

MATCHING TRANSFORMER: An adapter used primarily on non-cable ready TV's. One end has a "screw on" type connector and the other end has two flat leads that connect to the TV.

MENU: Information that will appear on the TV screen and give you operating directions.

MENU BUTTON: When the MENU button is pressed, you will be able to choose from a list of options:

- 1) Selecting the Program mode, to enter information for timer recordings.
- 2) Selecting the VCR SET UP mode, which includes OSD mode and language selection.
- 3) Setting the VCR for "NORMAL TV" or "CABLE TV."
- 4) Selecting the Input source (Tuner or Line).
- 5) Setting the clock.

MODE: The process of placing the VCR in any of its operating features. Ex: "PLAY ►" mode.

OSD (On Screen Display): Features and information that will appear on the screen.

OTR (One Touch Recording): Making immediate timed recordings with the press of a single button. These recordings can be set from 30 minutes to 9 hours.

REWIND (REW ◀▶): To move the tape rapidly in the reverse direction.

RF COAXIAL CABLE: Black insulated round cable used to connect the VCR to the TV.

SPECIAL EFFECTS: Viewing a Still Picture, Slow Motion or Fast Forward during playback of a tape.

SEPARATOR: An adapter used to separate TV signals (VHF-UHF) when having to connect the VCR to a TV with separate VHF and UHF terminals.

TAPE SPEEDS: This determines how fast the tape travels during a recording.

SP (Standard Play):

Fastest tape speed. Recording time for a T120 tape will be approximately 2 hours. (Best Picture Quality)

LP (Long Play):

Average tape speed. Recording time for a T120 tape will be approximately 4 hours (Playback Only).

SLP (Super Long Play):

Slowest tape speed. Recording time for a T120 tape will be approximately 6 hours.

TRACKING: For use when grainy streaks appear through the picture. This may be corrected by adjusting the Tracking Control.

VCR/TV BUTTON: This button turns the "VCR" indicator, on the front of the VCR, ON and OFF. When "VCR" is on, this prepares the VCR for viewing your recordings or tape playback on the TV. When off, all channel selections are made at the TV.

VCR: Video Cassette Recorder.

VIDEO IN/OUT: These are connectors (jacks) located on the back of the unit that are used to record the video from another source (IN), or play the video to another source (OUT).

WIRELESS REMOTE CONTROL: By pressing the buttons on the remote, signals are sent to the VCR to perform the desired task(s).

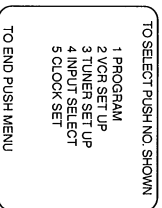

Main Menu



Accessories (Optional)	40	JOG/SHUTTLE Button	13, 24	SEARCH Button	12, 13, 16, 24
Accessories (Supplied)	40	Language Select	7, 18	Sensor (Remote)	15
Adding Channels	23	LINE Input	22, 27	Set the Clock	9
Audio Input/Output	17	LP (Long Play)	5	Shuttle Ring	13, 24
Auto Operation	25	Manual Tracking	25	SKIP SEARCH Button	12
Auto Rewind	25	MEMO(r)y Button	12, 26	SLOW Button	13
Auto Tracking	25	MENU Button	12, 18	SLP (Super Long Play)	5, 10, 19
Battery Installation	5	MTS Broadcast Stereo System	26	SP (Standard Play)	5, 10, 19
Cassette	5	MUTE Button	13	Special Effects	24
Cassette-Inside Light	14	NUMBER Buttons	13	Specifications	31
CHANNEL 3/4 Switch	7, 17	On Screen Display (OSD)	18	STATUS Button	12, 18
CHANNEL UP/DOWN Buttons	16	One Touch Recording (OTR)	19	STOP Button	12, 16
Channels above 13	23, 36	Optional Accessories	40	Tape Speed	5, 10, 19, 24
Cleaning	36	Other Hook-Ups You Can Try	32-35	Tape Speed Button	13
CLEAR Button	12	OTR Button	12, 19	Time (Clock)	9
Clearing Timer Programs	21	PAUSE/STILL Button	12, 24	Timer (Recording)	20, 21
Clock (Setting)	9	PLAY Button	8, 13, 16, 24	Timer Light	14, 20
Controls	12-17	Playback	8	Timer Programs (Checking)	21
Deleting Channels	23	POWER (VCR POWER) Button	12, 16	Timer Programs (Clearing)	21
Display Panel	14, 15	Precautions (Safety)	3	TRACKING Control	12, 25
Duplication	22	Programming for Timer Recording	20, 21	Trouble Checks	36, 37
EJECT Button	16	Rapid Scan	24	TV Position	8, 10
Erase Protection	5	REC(ord) Button	10, 12, 16	TV POWER Button	13
FAST FORWARD Button	12, 16	Record Tab	5, 10, 19, 20	TV Viewing	11
Features	4	Remote Control	12, 13	VCR Channel	7
Glossary	38	Requesting Service	36	VCR Light	9, 14, 16
GO-TO Button	12	Re-Recording	22	VCR Position	8
Go-To Function	26	REWIND Button	13, 16	VCR POWER Button	12
Hook Up Your VCR	6, 7	Rewind Power-off	25	VCR/TV Button	11, 12, 16
Input Select	11	RF Coaxial Cable	6, 40	VHS Hi-Fi Stereo System	27
Insert a Cassette	8, 10	Safety	3	Video Cassettes	5
Jog Dial	13, 24	Satellite Hook-Up	11, 31	VOLUME Buttons	13

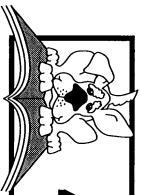

40

Accessories

SUPPLIED ACCESSORIES

Check to be sure the following items are packed with your VCR.

These accessories are provided to help you use or set up your VCR.

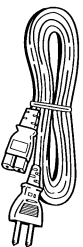

4835 321 17076

1 pc. AC Power Cord

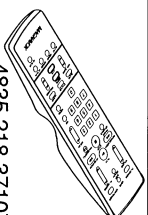

4835 218 37107

1 pc. Wireless Remote Control and 2 "AAA" batteries



4385 321 27022

1 pc. VHF/UHF Connecting Cable 75 Ohm

OPTIONAL ACCESSORIES

Maximize your viewing pleasure with State-Of-The-Art accessories designed specifically for your VCR.

The optional accessories shown in this booklet may be purchased from your local dealer, or may be ordered direct from Philips Consumer Electronics Company. Call toll free: **1-800-851-8885**

Or Write:

Philips Consumer Electronics Company
Marketing Dept.
P.O. Box 967
Greenville, TN
37744-0967

Prices subject to change without notice. Availability subject to change at time of purchase. When ordering accessories outside the U.S., please refer to the accessories manual, address, and prices for that country.

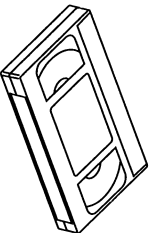

VHS T-120

V80107BK04

3 Pack T-120

Cassette Tape:

Protect your new video cassette recorder with quality tapes. Prevent oxide residue buildup on the heads and the rollers by using high-grade tapes. High-grade tapes will not snap or stretch during hold and will not degrade like lesser quality tapes. Tape runs from 2 to 6 hours and is made for years of viewing enjoyment.

V80107BK04 List \$10.99
Your Price \$8.99

1B6765E007

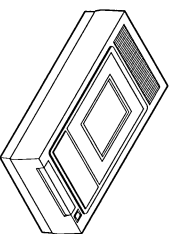

VHS Rewinder

SBV7040A01

VHS Rewinder:

Rewind your tape while recording or playing another tape. Rewinder is compact, lightweight, and durable. Starts to rewind when cover is closed and springs open when fully rewound. Features a clear see-through top panel. UL Approved.

SBV7040A01 List \$15.95
Your Price \$11.99

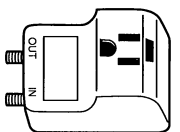

Cable TV/VCR Surge Protector

SRG9104

Cable TV/VCR Surge Protector:

Provides full protection from damaging voltage surges. The cable and antenna connections protect your VCR from power surges through your cable and antenna wires as well as your AC power connection. Has surge indicator light, EMI/RFI filter and is UL Approved.

SRG9104 List \$29.99
Your Price \$24.99

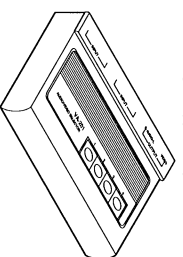

Audio/Video Select Switch Box

SBA2010A01

Audio/Video Select Switch Box:

Allows for the easy hookup of up to four different components without changing complicated wires such as Television, VCR, Laser Disc Player, and Satellite. Has four stereo audio/video inputs, one stereo audio/video output, and four selector switches to select desirable sources for viewing.

SBA2010A01 List \$39.95
Your Price \$29.95

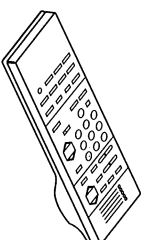

Universal Remote

AK9033GY03

"The Smart One" Universal Remote Control:

Programmed to work both your VCR as well as most brands of TVs and Cable Converters. Can learn virtually any infrared component not preprogrammed such as CD Players, Audio Systems, Satellite Systems, etc. "The Smart One" can operate up to five different components and thus eliminates the need for having a remote for each piece of electronic equipment.

AK9033GY03 List \$49.95
Your Price \$39.95

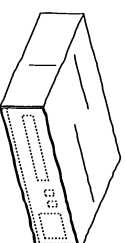

VCR Dust Cover

SBV1143A02

VCR Dust Cover:

An attractive and inexpensive way to prevent dust, dirt, spills, and scrapes from harming your VCR. Features a quality leather-like heavy duty vinyl, a clear see-through front panel, back cut out for wires, and a unique padded inner liner to protect and guard against heat damage.

SBV1143A02 List \$4.99
Your Price \$3.99

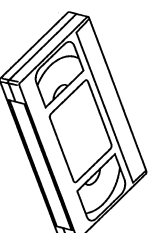

VHS Dry Head Cleaner

SBV1141A01

Dry Head Cleaner:

Keep your VCR running smoothly and your pictures clear and sharp with a quality Dry Head Cleaner. It will assure clear sharp pictures after every cleaning and will provide up to 100 cleanings. If quality tapes are used, this Dry Head Cleaning unit will last for years of VCR service.

SBV1141A01 List \$9.95
Your Price \$7.95

PU36278-64